

Your Futaba transmitter programming can be updated easily online. When functions are added or improved, the update file can be downloaded from our website. Copy the update files to the SD card and then use the following procedure to update the program. Check our web site for the FAQ regarding updating for more information.

## Updating procedure

**Note:** If the battery fully discharges during program updating, updating will fail. When the remaining battery capacity is 50% or less, always recharge the battery before updating.

**Note:** The model data in the transmitter can be used unchanged after updating, but to be safe, back up the model data before updating.

1. Download the zip file of the update data from our website.

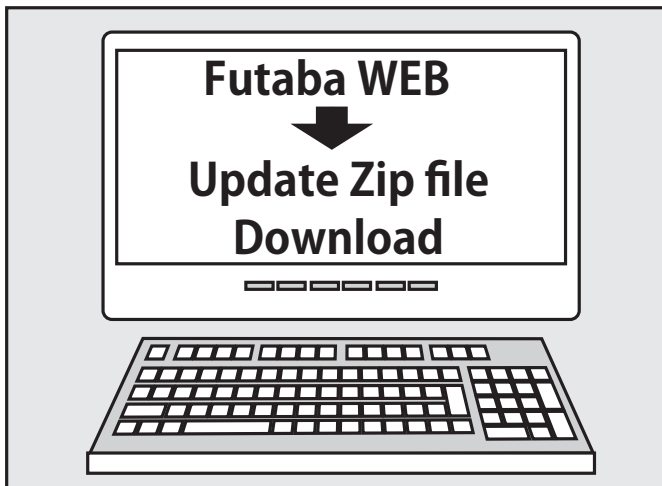

2. Extract the zip file on your computer.
3. The "FUTABA" folder will be created on your computer.
4. Copy the "FUTABA" folder into your SD card.

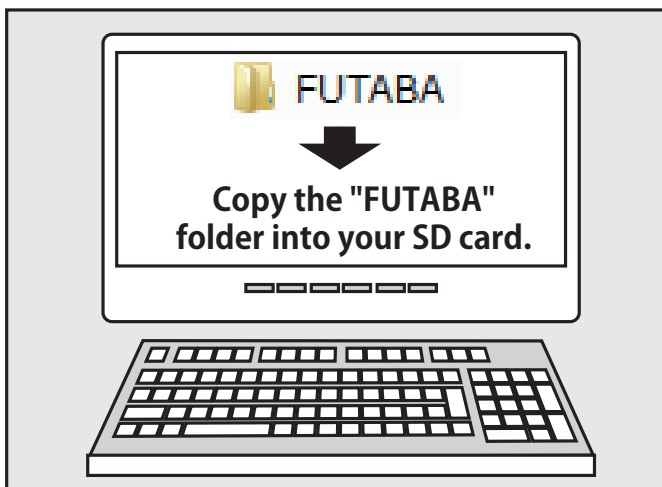

**Note:** If the SD card has already had "another FUTABA" folder before you make a copy, the "FUTABA" folder is OVERWRITTEN.

5. Insert the SD card with "FUTABA" folder that contained the update software into the SD card slot on your transmitter.

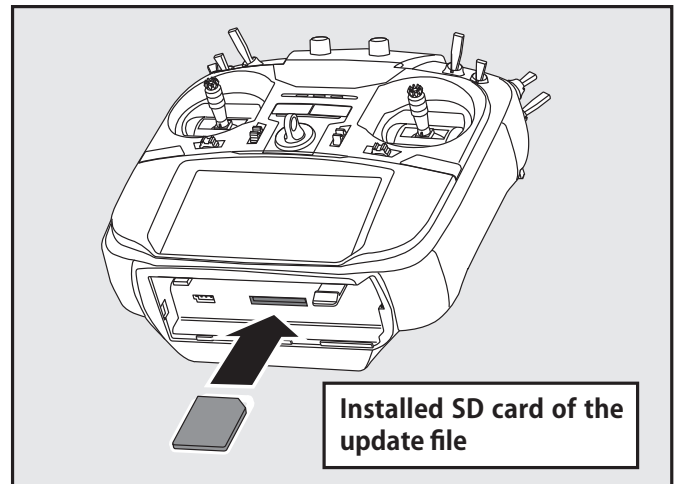

6. Turn on the transmitter power while pressing down the "HOME/EXIT" button. The update screen appears on the LCD display of your transmitter and the software update is started.

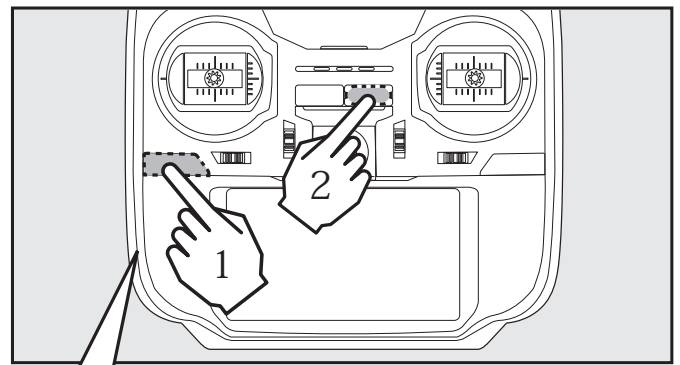

**Press the HOME/EXIT switch and turn on**

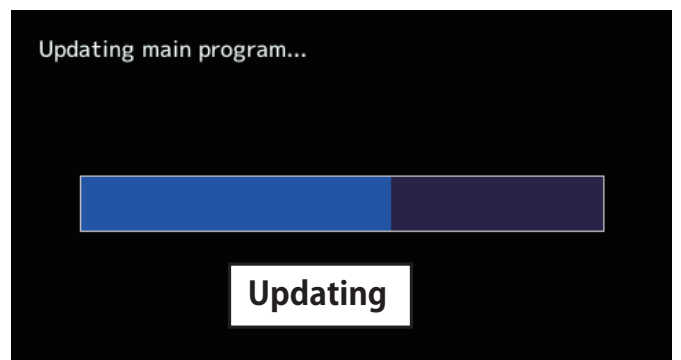

## For FX-36

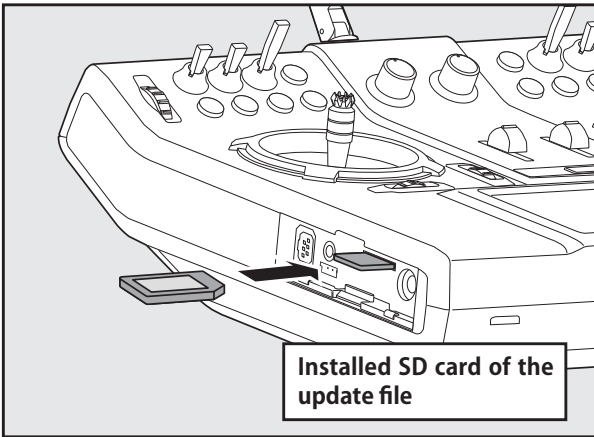

6. Turn on the transmitter power while pressing down the "H/E" button. The update screen appears on the LCD display of your transmitter and the software update is started.

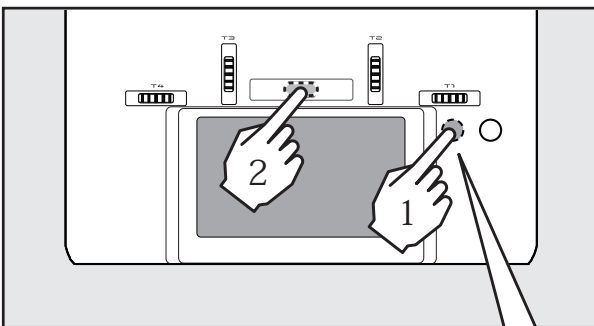

Press the H/E switch and turn on

7. When the software update is completed, "Completed" message is shown on the LCD display of your transmitter. (Show below picture.)

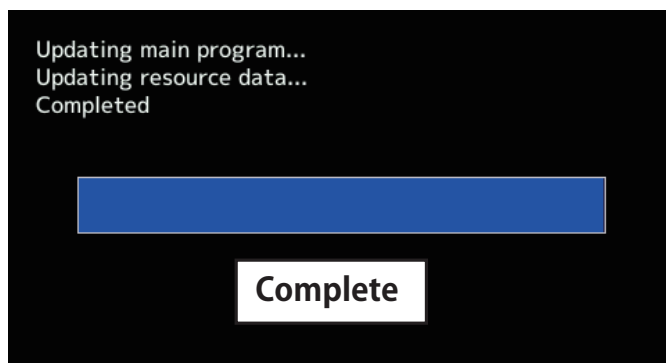

8. Turn off the power switch of your transmitter and remove the SD card from the card slot.

## Possible Problems

When one of the error messages shown below appears on the LCD screen your transmitter, the software update will not be completed.

### "Low battery."

Software update is postponed because of low battery. Retry the software update after the battery is recharged.

### "Update file not found."

The transmitter cannot find the update file on the SD card. Check to be sure all the update files have been copied onto the SD card.

### "Broken file."

The transmitter detects the update file error. The update file may be broken or for another transmitter.

### "Write error."

The software update procedure is stopped for an unknown reason. Contact your local service center when this error message appears on the LCD screen of your transmitter.



**Don't absolutely remove the battery and the SD card from the transmitter during the update.**

There is a possibility that the transmitter will be damaged.

Recovering a failed update

If you failed to update for any reason, it may transmitter will not start.

In that case, please update again transmitter in the following procedure.

1. Detach the battery from the transmitter.
2. Insert the SD card that contained the update files to the transmitter.
3. Attach the battery to the transmitter while pressing down the "HOME/EXIT" button.
4. The update will start.

Even after the above steps, if the transmitter fails to update or does not start, please have it serviced.

This software updates or alters the functions and features noted below. The instructions and information that follow are meant as a supplement to the original instruction manual that accompanied the T16SZ transmitter. Please refer to the original instruction manual where applicable, but replace the steps indicated below with these instructions. Please check to ensure that the update has been installed.

- 1) Select the System Menu.
- 2) Touch the [Information] button.
- 3) Confirm that the information in the display indicates the version numbers as noted above.

## 1. Fixed telemetry voice for Futaba ESC and Hobbywing ESC.

### V4

### 1. Compatible with Futaba ESC MC-980H/A, MC-9130H/A, MC-9200H/A

Supports the telemetry function of MC-980H/A, MC-9130H/A, and MC-9200H/A.

- ◆ Register the ESC with the transmitter. The registered ESC is displayed as "Futaba ESC".

- ◆ ESC telemetry display screen

The ESC status is displayed. Alarm setting is also possible.

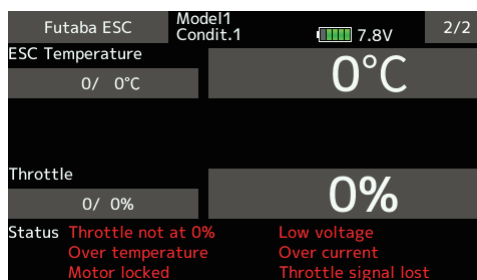

\* The current and capacity consumption display may vary depending on the usage conditions, so use it as a guide.

### 2. Hobbywing ESC telemetry compatible

Supports the telemetry function installed in some Hobbywing ESCs.

- ◆ The registered ESC is displayed as "Hobbywing ESC".

For details on Hobbywing ESC telemetry support, refer to the Hobbywing website.

### 3. Compatible with SCORPION ESC telemetry

Added support for SCORPION POWER SYSTEM ESC some models.

This software updates or alters the functions and features noted below. The instructions and information that follow are meant as a supplement to the original instruction manual that accompanied the transmitter. Please refer to the original instruction manual where applicable, but replace the steps indicated below with these instructions. Please check to ensure that the update has been installed.

- 1) Select the System Menu.
- 2) Touch the [Information] button.
- 3) Confirm that the information in the display indicates the version numbers as noted above.

**1. Fixed defect**

Fixed a problem that could not be linked with R3206SBM.

**1. Fixed defect**

Fixed a problem that telemetry reception time.

**1. Add O.S.ENGINE EM-100 Telemetry function**

**FASSTest, T-FHSS**

Supports EM-100 firmware version Ver.8.00 or later.



**Important:** When you update your radio to V3.9 and add the Model ID function, you must re-link existing FASSTest or T-FHSS receivers in your current models.

**1. Add Model ID**

**FASSTest, T-FHSS**

As an added level of safety in the form of Model ID, which will prevent the accidental control of a model when using a different model data by preventing link.

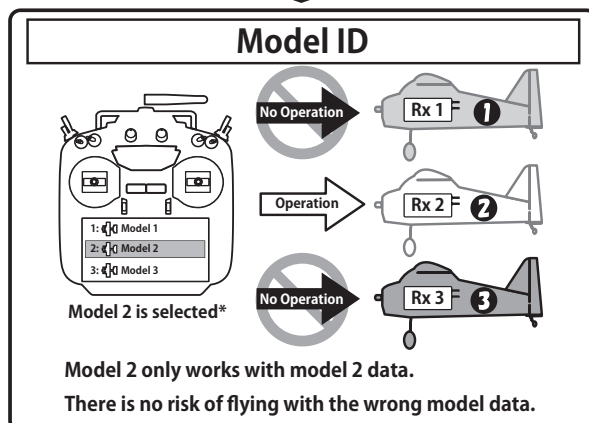
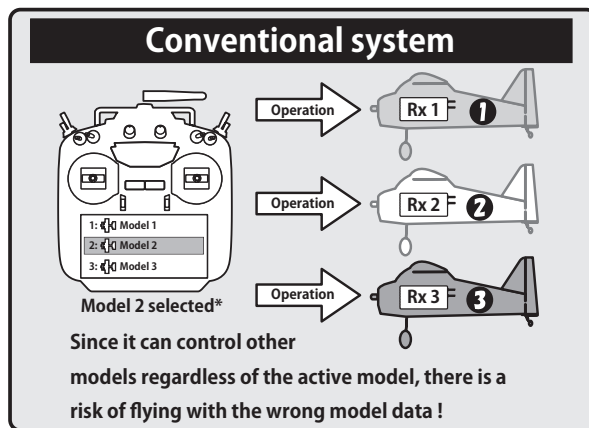



In Ver 3.9 or later software with the model ID function added, model data saved on the SD card cannot be called using the model select function. To use the model data of the SD card, copy the model data to the transmitter. If the model data of the SD card was selected before the update, an error message will be displayed at the first startup after the update, and the model will automatically switch to the model data of the transmitter.

## Link is required when a new model is made from a model selection.

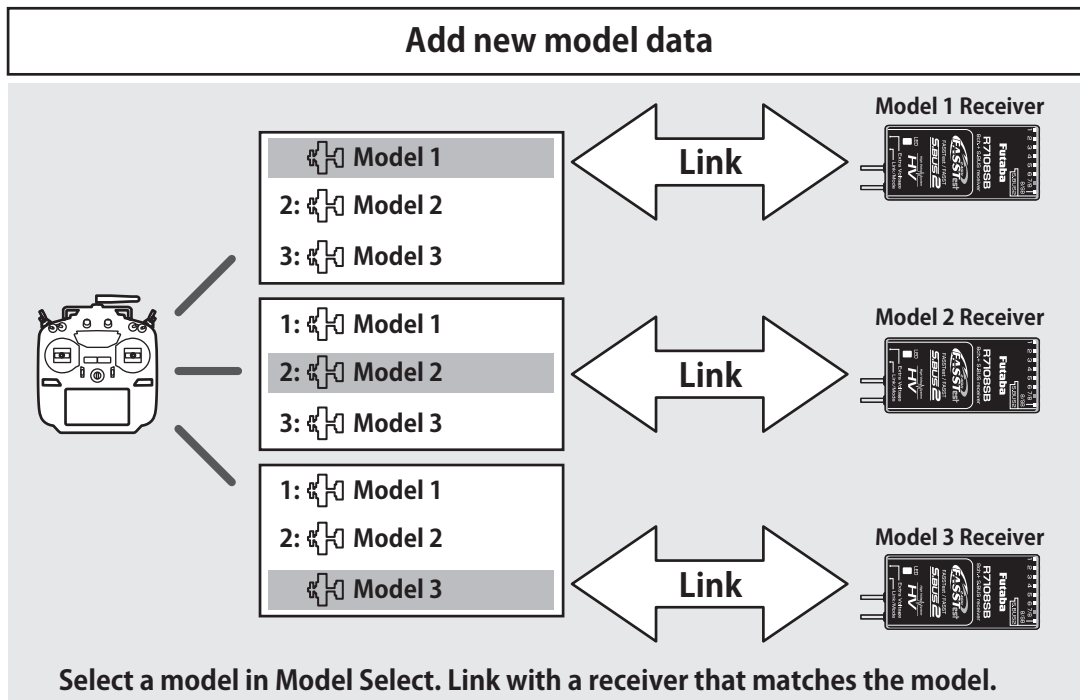

- In the system types (FASSTest, T-FHSS) compatible with the model ID function, a unique ID number (model ID) is set to each model data. Linking with a receiver stores the model ID of the model data in that receiver. The receiver operates only when it receives radio waves transmitted using model data that matches the stored model ID. As a result, the receiver does not operate even if model data of an unintended setting is used by mistake, so it is possible to prevent a malfunction due to a model selection mistake.

- If you want to use different model data from the model data that you have been using, link again.
- Model ID feature is enabled only if the system type is FASSTest or T-FHSS. Please note that model ID function can not be used on other systems.
- For safety reasons, model ID function can not be disabled.
- Model ID is automatically set when copying or adding model data.

### When using R3004SB

- When using the **R3004SB**, set "Receiver" in the system type screen T-FHSS mode setting to [R3004SB]. When using other T-FHSS compatible receivers, set "Receiver" to [Normal].

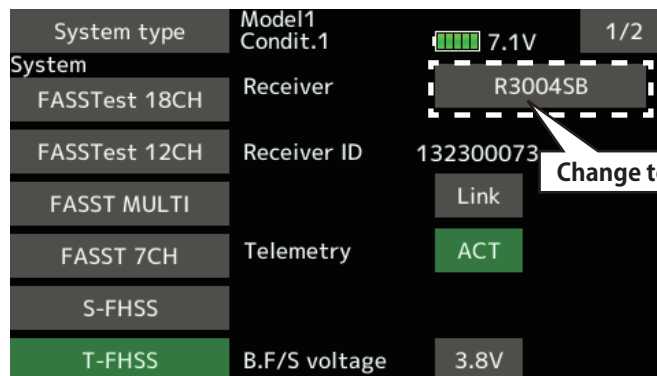

R3004SB receiver does not support model ID function.

## 2. Improved model copy function

Conventionally, only the model data currently active can be copied. In version 3.9, you can copy any model data.

This software updates or alters the functions and features noted below. The instructions and information that follow are meant as a supplement to the original instruction manual that accompanied the transmitter. Please refer to the original instruction manual where applicable, but replace the steps indicated below with these instructions. Please check to ensure that the update has been installed.

- 1) Select the System Menu.
- 2) Touch the [Information] button.
- 3) Confirm that the information in the display indicates the version numbers as noted above.

## 1. Telemetry sensor assignment

Third-party telemetry sensor JetCat V10 can be assigned from slot 1. This allows JetCat V10 and PowerBox to be used simultaneously.

- ### 1. Fixed defect
- Fixed a problem that an AFR rate of conditions 2 to 4 ("Gasvorw. 1" to "Gasvorw. 3") cannot be set properly when the language mode is set to German and model type of a model data is Helicopter.

## 1. Compatibility of model data created with T18SZ 70th anniversary model

It is necessary to update software to Ver.3.6 or later in order to use model data created with the T18SZ 70th anniversary model.

\* There are no difference in functions between the 70th anniversary model and standard model.

## 1. Telemetry Airspeed sensor function

The T18SZ/T16SZ/FX-36 has been made compatible with the telemetry airspeed sensor.

### ◆ Airspeed sensor is registered with the transmitter.

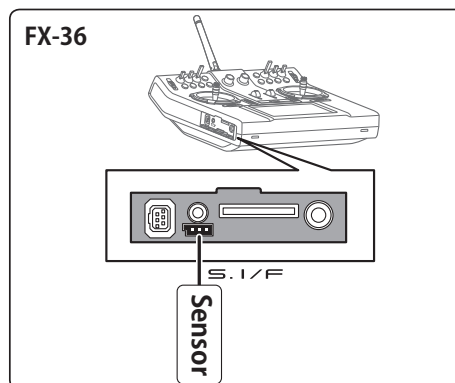
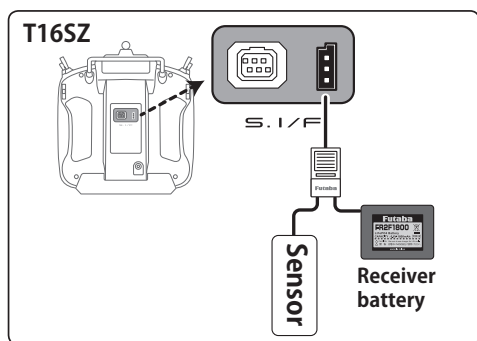
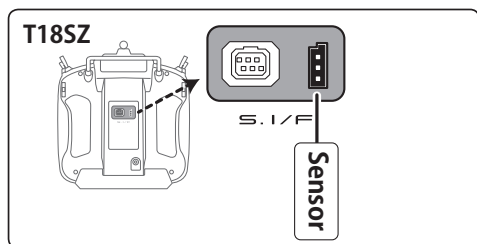

\*Airspeed sensor must be installed in the aircraft.

- ① Connect the sensor to the transmitter as shown in the figure.
- ② [Linkage menu] → [Sensor] → [Page 3/3] is opened from the transmitter.
- ③ Tap [Register]
- ④ Complete registration and remove sensor from the transmitter.

### ◆ How to display the Airspeed sensor screen.

- ① [Linkage menu] → [Telemetry]

- ② Tap [Speed sensor]



## ◆ Speed sensor screen

Max. and min. values since the power was turned ON will display.

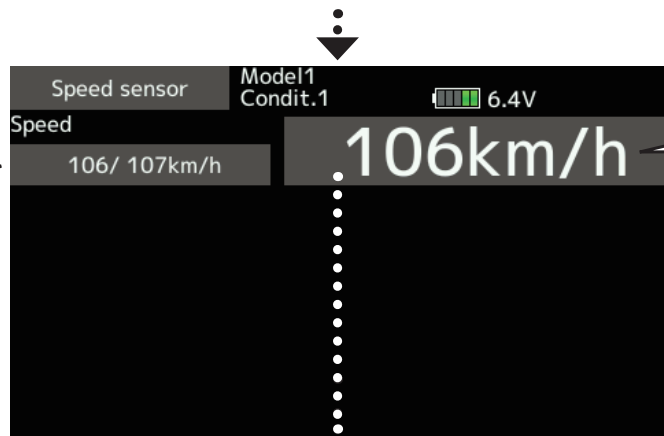

Airspeed

## ◆ Alarm setting

↑ An upward arrow indicates the alarm will sound when the speed reaches above your set value.

↓ A downward arrow indicates the alarm will sound when the speed reaches below your set value.

The ON/OFF switch of Speech is chosen.

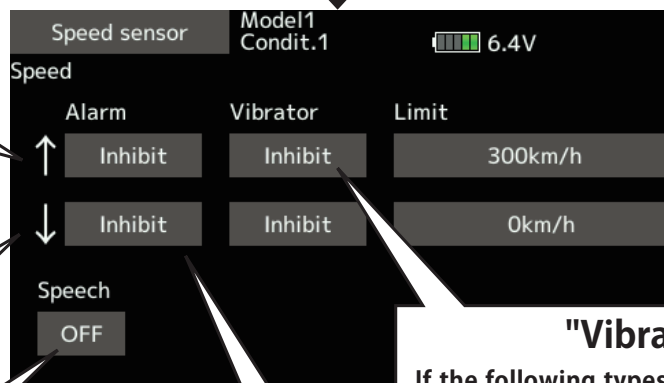

A setup of the speed on which the alarm operates.

Alarm is chosen from Buzzer, Voice, and Inhibit.

### "Vibrator" type

If the following types are selected, the transmitter will vibrate during the warning.

- Type 1 \_\_\_\_\_→
- Type 2 \_\_\_\_\_→
- Type 3 - - - - -→

## 2. CRSF Protocol for TBS

The T18SZ/T16SZ/FX-36 has been made compatible with the CRSF (TBS) protocol.

■ Bidirectional communication function of CRSF is not supported.

① [Linkage menu] → [System Type] → [Page 2/2] is opened from the transmitter.

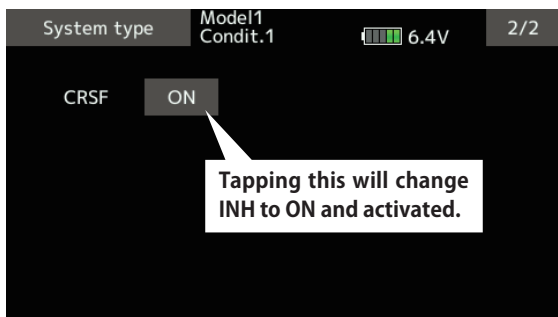

② Tap the "CRSF" button to [ON]. A signal conforming to the CRSF standard is output from the S.BUS setting connector (S.I/F) of the transmitter.

! Futaba is not responsible for damage sustained by combination with parts other than Futaba Genuine equipment.

■ When using CRSF, the S.BUS servo setting function and [Reload] [Register] [Change slot] functions cannot be used. When setting S.BUS servo and sensor, set CRSF to INH.



This software updates or alters the functions and features noted below. The instructions and information that follow are meant as a supplement to the original instruction manual that accompanied the T18SZ/T16SZ/FX-36 transmitter. Please refer to the original instruction manual where applicable, but replace the steps indicated below with these instructions. Please check to ensure that the update has been installed.

- 1) Select the System Menu.
- 2) Touch the [Information] button.
- 3) Confirm that the information in the display indicates the version numbers as noted above.

---

**1. Fixed defect**

- ◆ Fixed a problem that the power switch may not operate when the timer alarm is set to [Constant] mode.
- ◆ Fixed a problem that the position of the stick switch is not displayed correctly on the AFR. (FX-36 only)
- ◆ Fixed a problem that the power switch may not operate depending on the position of the trim dial. (FX-36 only)

This software updates or alters the functions and features noted below. The instructions and information that follow are meant as a supplement to the original instruction manual that accompanied the T18SZ/T16SZ/FX-36 transmitter. Please refer to the original instruction manual where applicable, but replace the steps indicated below with these instructions. Please check to ensure that the update has been installed.

- 1) Select the System Menu.
- 2) Touch the [Information] button.
- 3) Confirm that the information in the display indicates the version numbers as noted above.

---

**1. Change of the trainer connector power supply specification**

The update enables the trainer connector to supply power to external equipment connected to the trainer connector, when turning on the power by pressing the power switch in the trainer student mode.

---

**2. Telemetry sensor made by O.S.ENGINES MFG.**

It corresponds to O.S. EM-100 flight controller(under development). For details, please refer to the instruction manual of EM-100.

\*The EM-100 is not handled at Futaba.

**!** Futaba is not responsible for damage sustained by combination with parts other than Futaba Genuine equipment.

**!** When connecting Futaba transmitters to the trainer code, do not operate the power switch on the student side transmitter and operate the power switch on the teacher side transmitter as before. The student side transmitter turns power automatically in conjunction with the teacher side.

---

**3. Fixed defect**

- ◆ The count value of the integration timer has been corrected.
- ◆ Fixed the behavior of Ailevator.
- ◆ Fixed a problem that seldom the power switch does not work.



This software updates or alters the functions and features noted below. The instructions and information that follow are meant as a supplement to the original instruction manual that accompanied the T16SZ transmitter. Please refer to the original instruction manual where applicable, but replace the steps indicated below with these instructions. Please check to ensure that the update has been installed.

- 1) Select the System Menu.
- 2) Touch the [Information] button.
- 3) Confirm that the information in the display indicates the version numbers as noted above.

### 1. Telemetry display (The extension of the number of telemetry data which is shown)

The number of telemetry data which is displayed to Telemetry display screen is extended. It is 16 items (4 pages) maximum.

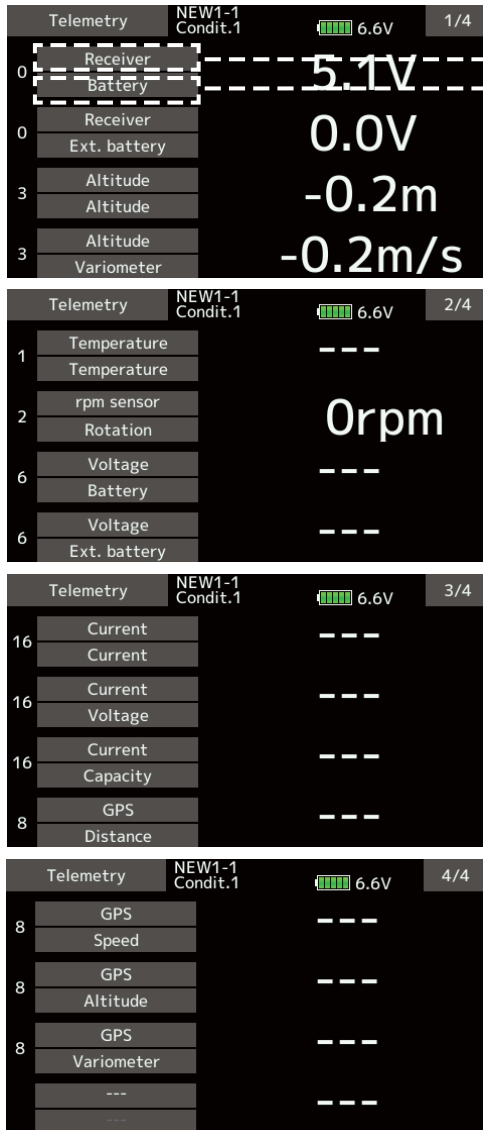

#### Sensor selection screen

For some sensor types, you can choose the display item. Tap to select.



### 2. Timer Alarm

Added a setting to keep the alarm after the alarm set time.

Constant: The alarm does not stop  
One time: Stop the alarm at once



### 3. Model select

Model data of FX-32 can be used.

### 4. Data Converter

FX-30 and T12FG have been added to the data converter compatible models.

The transmitter name is displayed on icon.



#### Sensor type selection screen

You can choose which type of sensor to displays. Tap the sensor type.

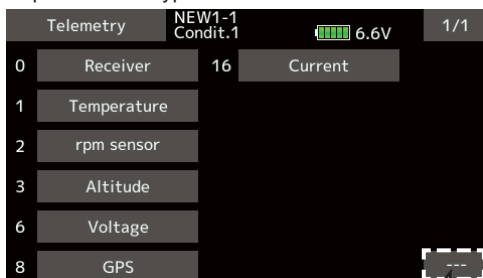

If you do not want to display telemetry data on the telemetry monitor screen, select "----".

### 5. Butterfly Elevator setting (Glider)

Added fine tuning function to butterfly elevator setting.

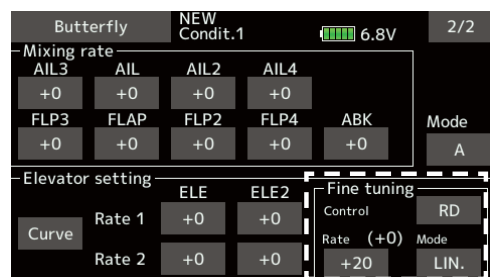

\*When Flying wing type, it was made not to display Elevator setting.

## 6. Butterfly mixing mode (Glider)

The operation of Butterfly mixing was changed.

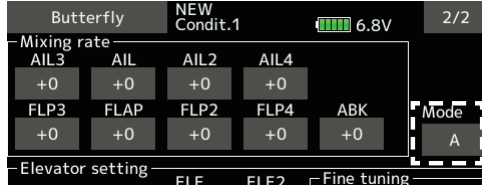

Mode A, mode B selection added.

### • Mode A

(Normal)

- The butterfly operation direction is reversed at the neutral position (50%) of the throttle stick.

At offset 20



At offset 70

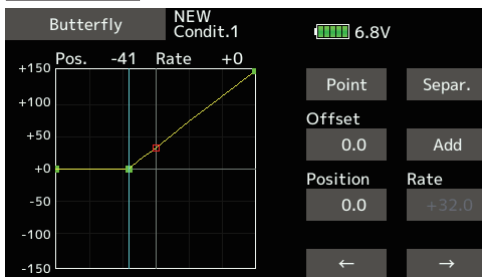

The direction of butterfly motion is reversed.

### • Mode B

(Throttle stick full stroke MODE)

- It does not reverse at the neutral position, so you can set the butterfly operation start point with the full stroke of the throttle stick.

At offset 20



At offset 70

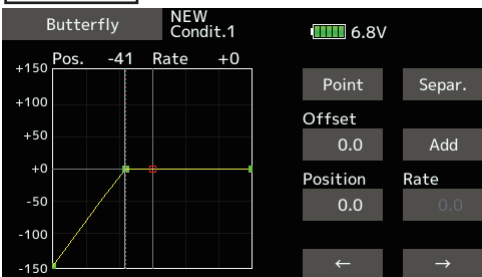

The direction of butterfly motion is not reversed.

## 7. Butterfly Differential rate (Glider)

The operation of Butterfly Differential rate was changed.

- ◆ When Butterfly Differential rate is "+", Up rate is decrease and DOWN rate is increase.
- ◆ When Butterfly Differential rate is "-", the calculation method of UP/DOWN and a direction become reverse.

## 8. Error correction for Failsafe screen

A fault that a fail-safe position indicator is not shown on the Failsafe screen in FASST-7ch mode has been fixed.

## 9. Manual change page 30

This supplement contains information for correcting manual errors. Refer to the following corrected items.

Remove the transmitter's rear rubber grips.  
(When using Mode 1, you will need to remove the side cover.)

