

This software updates or alters the functions and features noted below. The instructions and information that follow are meant as a supplement to the original instruction manual that accompanied the T18SZ transmitter. Please refer to the original instruction manual where applicable, but replace the steps indicated below with these instructions. Please check to ensure that the update has been installed.

- 1) Select the System Menu.
- 2) Touch the [Information] button.
- 3) Confirm that the information in the display indicates the version numbers as noted above.

1. Hysteresis-type and box-type can be selected in a hardware select screen.

When a stick, trim lever, or VR is used as a switch, the following 4 modes can be selected.

◆ Linear • Hysteresis mode

This setting method selects function ON/OFF based on the set point. Hysteresis (dead band) can be set to ON and OFF. The ON and OFF positions can be reversed with the Reverse button.

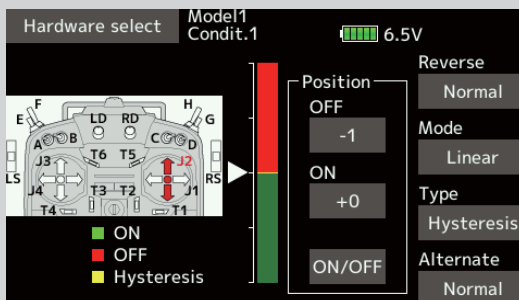

◆ Symmetry • Hysteresis mode

The operation is the same as the linear hysteresis mode, but left and right (up and down operations are symmetrical about the neutral position). For example, when you want to switch DR1 with the aileron stick, when the stick is moved to the left or right, DR1 can be turned ON at the same left and right position.

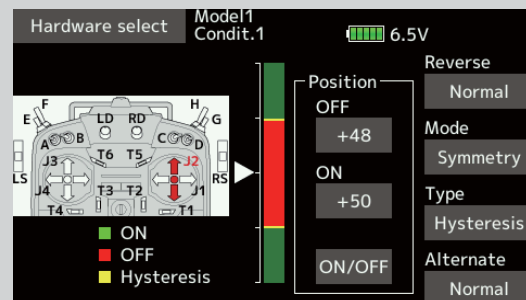

◆ Linear • Box mode

This mode turns on the switch within a range of 2 points. Each point can be set. The ON and OFF positions can be reversed with the Reverse switch.

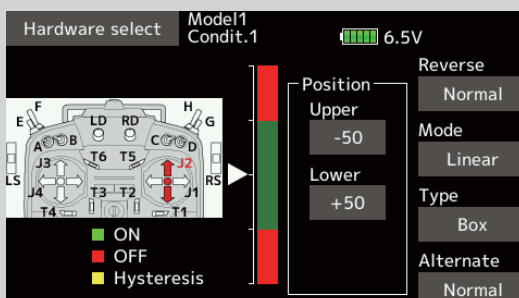

◆ Symmetry • Box mode

The operation is the same as the linear box mode, but left and right (up and down) operation is symmetrical about the neutral position.

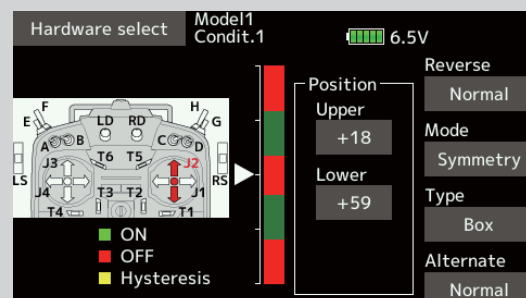

When shifting the ON/OFF point

The ON/OFF and hysteresis (dead band) boundary point (there are 2 points: top and bottom) position can be shifted. ON/OFF is possible at a free position.

- ◆ Area Green : ON
- ◆ Area Red : OFF
- ◆ Area Yellow : Hysteresis (Dead band)

[Setting method]

1. Move the stick, etc. to the point you want to shift and touch the [ON/OFF] button. The boundary points change.

Current stick position

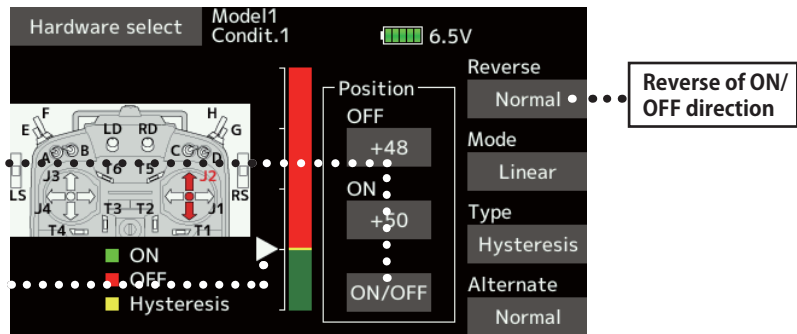

Reverse of ON/OFF direction

[Setting method] → Box Type

1. Move the stick to the point you want to shift upper side.
2. Touch the [Upper] button. The boundary points change.
3. Move the stick to the point you want to shift lower side.
4. Touch the [Lower] button. The boundary points change.

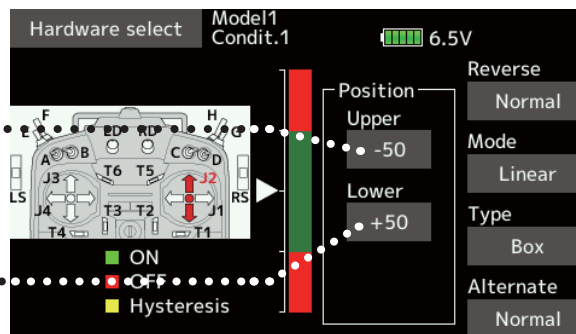

● Symmetry

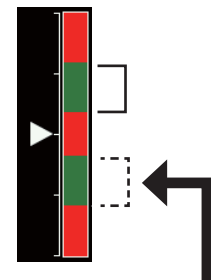

When Upper (Lower) is set, at the same time, Lower (Upper) is also set.

Hysteresis : Hysteresis (dead band) can be set to ON and OFF

[Setting method] → Linear Type

1. Move the stick to the off point you want to shift and touch the [OFF] button. The off points change.
2. Move the stick to the on point you want to shift and touch the [ON] button. The on points change.

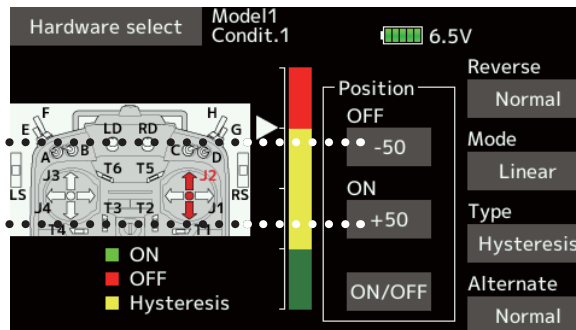

● Symmetry

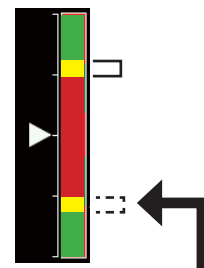

When Upper (Lower) is set, at the same time, Lower (Upper) is also set.

2. It corresponded to the following sensors.

Refer to the sensor instruction manual for more information.

- Kosmik ESC
- Castle TLO
- JetCat V10
- PowerBox

©Copyright 2016. No part of this manual may be reproduced in any form without prior permission. The contents of this manual are subject to change without prior notice. While this manual has been carefully written, there may be inadvertent errors or omissions. Please contact our service center if you feel that any corrections or clarifications should be made.

FUTABA CORPORATION Phone: +81 475 32 6982, Facsimile: +81 475 32 6983
1080 Yabutsuka, Chosei-mura, Chosei-gun, Chiba 299-4395, Japan

©FUTABA CORPORATION 2016, 3 (1)

V1.4

This software updates or alters the functions and features noted below. The instructions and information that follow are meant as a supplement to the original instruction manual that accompanied the T18SZ transmitter. Please refer to the original instruction manual where applicable, but replace the steps indicated below with these instructions. Please check to ensure that the update has been installed.

- 1) Select the System Menu.
- 2) Touch the [Information] button.
- 3) Confirm that the information in the display indicates the version numbers as noted above.

1. Curve setting operation

Point curves or spline curves of up to 11/17 points can be used. (Initial value: 11/9 points) **The set points can be freely increased, decreased, and offset.**

◆ Point addition method

- ① Open the screen of a mixing curve with the curve function.

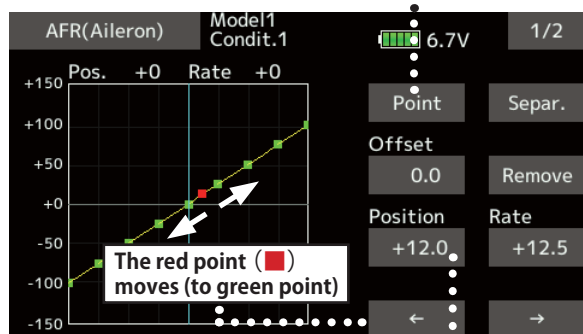
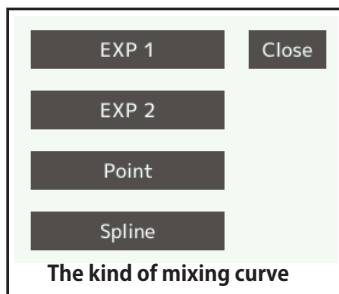

- ② Tap the "Position" button.

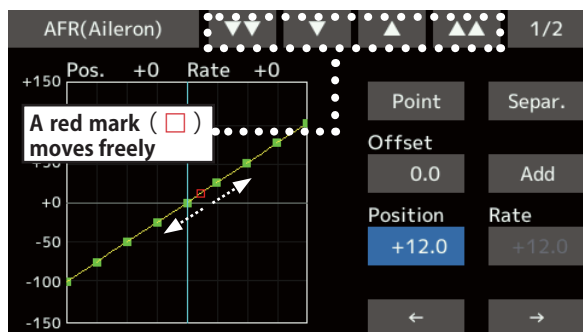

- ③ Tap the "▼▼""▼""▲""▲▲" button and select the position (mark red square) you want to add.

- ④ When the "Add" is tapped, the point is added. (red square) → (red square)

*A new point is created.

- ⑤ Press "Rate" and use the up/down arrows to adjust the rate points up or down.

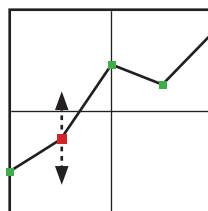

◆ Point deletion method

- ① Use the move between points button [←] or [→]

and select the point. (The red point is the selected point.)

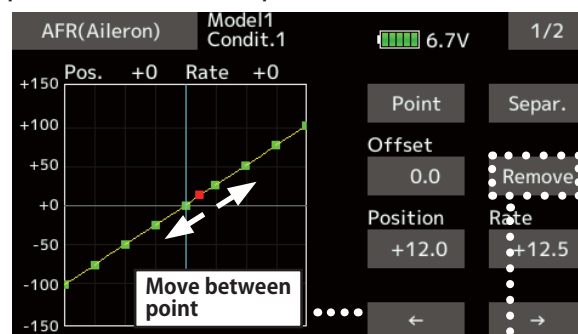

- ② Tap the [Remove] button. (The selected point becomes an outlined point)

- ③ Use the move between points button [←] or [→].

*The point is deleted.

2. Curve setting operation Spline curve

Addition of spline curve setting.

Setting method is same at spline and point.

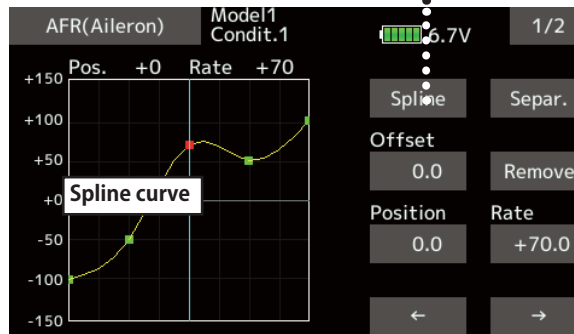
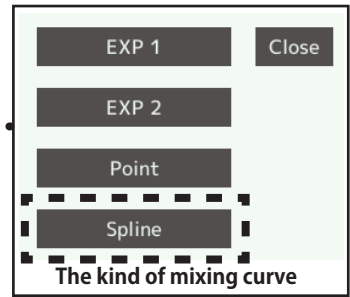
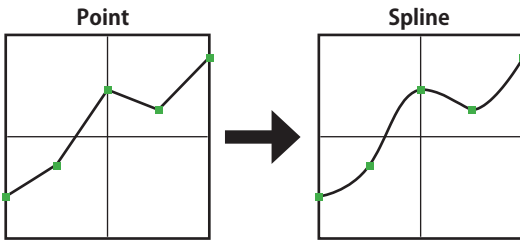

3. SBS-01C current sensor function

The T18SZ has been made compatible with the SBS-01C current sensor. The SBS-01C has the capability of measuring current, voltage and capacity (consumption) from drive battery at the same time.

*Current sensor must be installed in the aircraft.

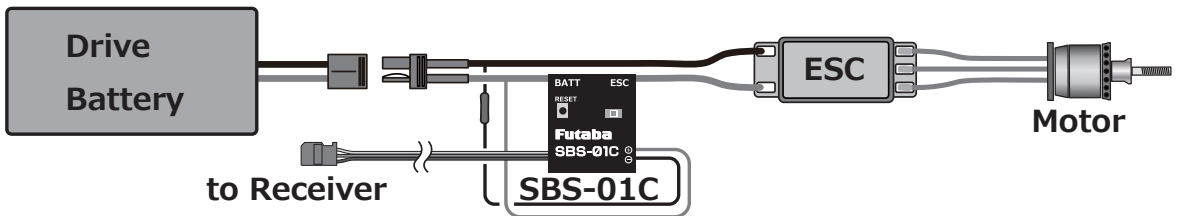

◆ SBS-01C is registered with a transmitter.

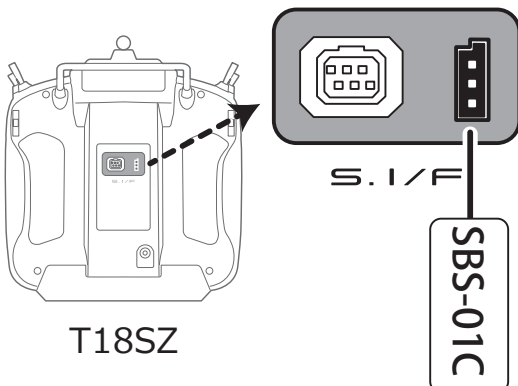

- ① Connect the sensor to the T18SZ as shown in the figure above.
- ② [Linkage menu] → [Sensor] → [Page 3/3] is opened from the T18SZ.
- ③ Tap [Register]
- ④ Complete registration and remove SBS-01C from the transmitter.

◆ **Calling of a current sensor screen.**

① [Linkage menu] → [Telemetry]

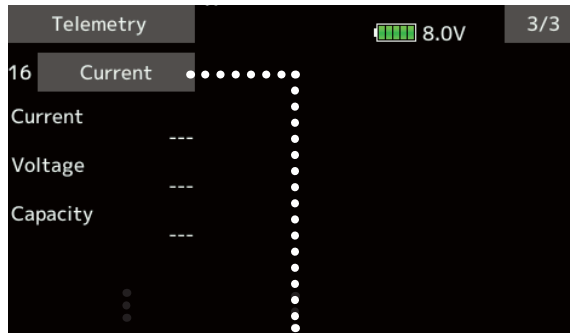

② Tap [Current]

◆ **Current sensor screen**

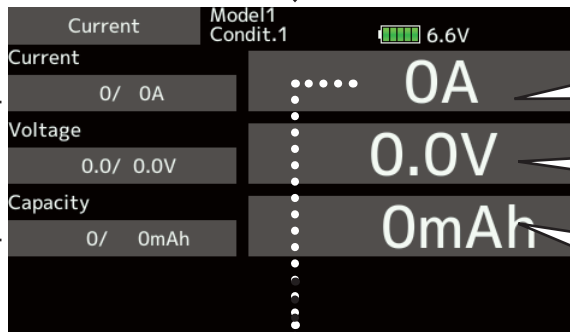

Max. and min. values since the power was turned ON will display.

Tapping this will take you to the settings screen for the current alarm

Tapping this will take you to the settings screen for the voltage alarm

Tapping this will take you to the settings screen for the consumption capacity alarm

◆ **Alarm setting**

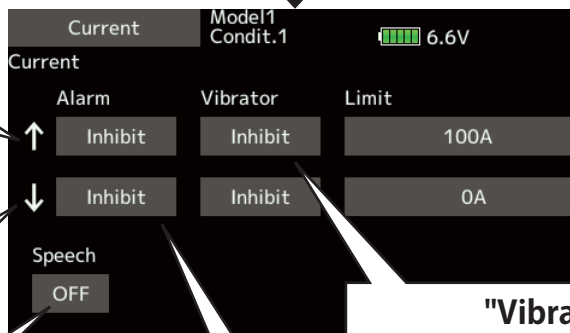

↑ An upward arrow indicates the alarm will sound when the current reaches above your set value.

↓ A downward arrow indicates the alarm will sound when the current reaches below your set value.

The ON/OFF switch of Speech is chosen.

Alarm is chosen from Buzzer, Voice, and Inhibit.

A setup of the current on which the alarm operates.

"Vibrator" type
If the following types are selected, the transmitter will vibrate during the warning.

Type 1 →

Type 2 → →

Type 3 → → → →

4. SD card icon

● When model data on a SD card is used, this icon appears.

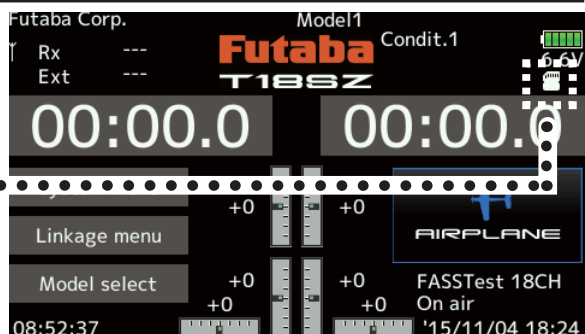

5. Stick mode

Addition of stick mode function.

Mode 2 or Mode 1 can be chosen.

But, it isn't changed until data is reset.

To change the mode the stick ratchet must be changed. Request that this be done by Futaba Service. (Charged modification)

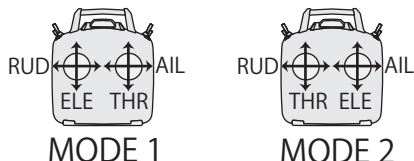

◆ System menu change

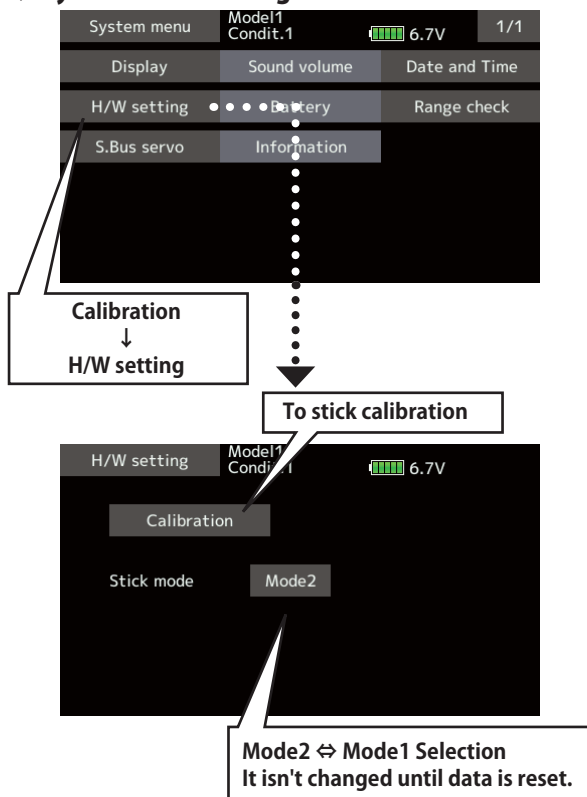

6. Throttle stick position alarm

< Airplane/Glider >

When the old version makes the function of the throttle stick a motor, a throttle stick position alarm has not started.

When the new version makes the function of the throttle stick a motor, a throttle stick position alarm has started.

7. Name change on the model menu

< Airplane/Glider >

Model menu	Model1 Condit.1	6.4V	1/2
Servo monitor	Condition select	AFR	
Dual rate	Program. mixes	Aileron differential	
Flap setting	AIL → Camber flap	AIL → Brake flap	
Aileron → Rudder	Elevator → Camber	Camber mixing	
Airbrake → ELE	Camber flap → ELE	Rudder → Aileron	
Rudder → Elevator	Snap roll	Air brake	

8. Butterfly elevator curve function

< Glider >

- When offsetting the butterfly operation reference point, operate to the point you want to change and then touch the Offset button. The reference point displays 0%. When [Yes] is touched, the reference point is changed. Then, "Initialize elevator curve?" appears, allowing you to confirm your setting.

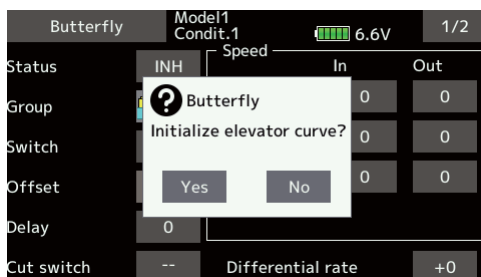

- The offset position is indicated by a red dotted line by an elevator curve.

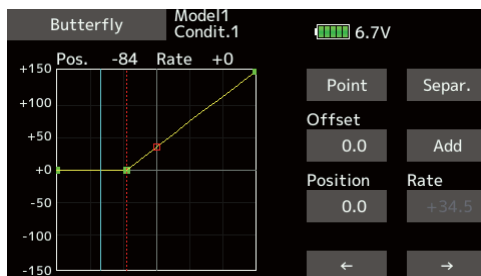

9. T-FHSS dual receiver function

< T-FHSS >

The dual receiver function can't be used for T-FHSS. When T-FHSS is chosen, dual receiver function isn't shown on a system type screen.