

Your Futaba transmitter programming can be updated easily online. When functions are added or improved, the update file can be downloaded from our website. Copy the update files to the SD card and then use the following procedure to update the program. Check our web site for the FAQ regarding updating for more information.

Updating procedure

Note: If the battery fully discharges during program updating, updating will fail. When the remaining battery capacity is 50% or less, always recharge the battery before updating.

Note: The model data in the transmitter can be used unchanged after updating, but to be safe, back up the model data before updating.

1. Download the zip file of the update data from our website.

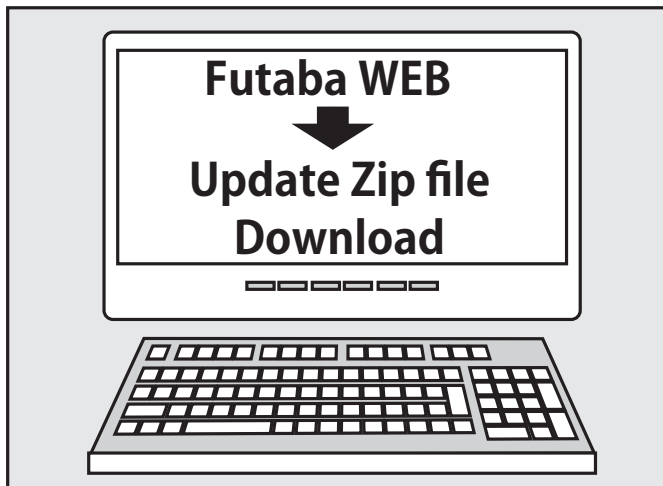

2. Extract the zip file on your computer.
3. The "FUTABA" folder will be created on your computer.
4. Copy the "FUTABA" folder into your SD card.

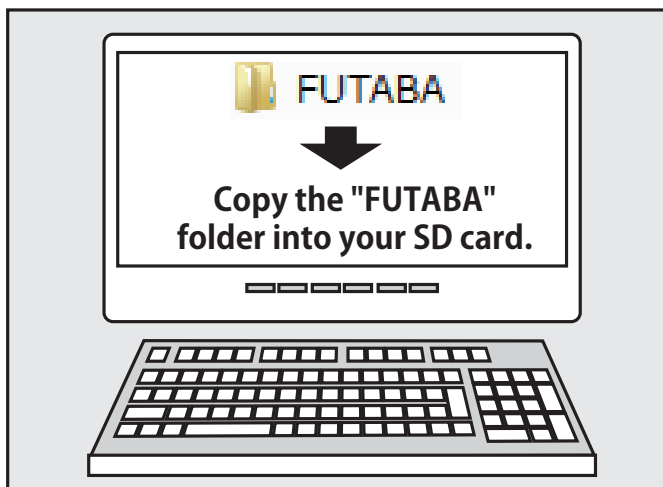

Note: If the SD card has already had "another FUTABA" folder before you make a copy, the "FUTABA" folder is OVERWRITTEN.

5. Insert the SD card with "FUTABA" folder that contained the update software into the SD card slot on your transmitter.

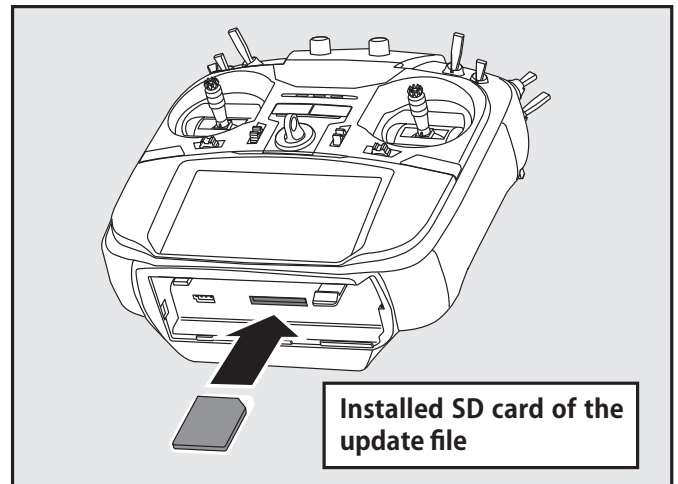

6. Turn on the transmitter power while pressing down the "HOME/EXIT" button. The update screen appears on the LCD display of your transmitter and the software update is started.

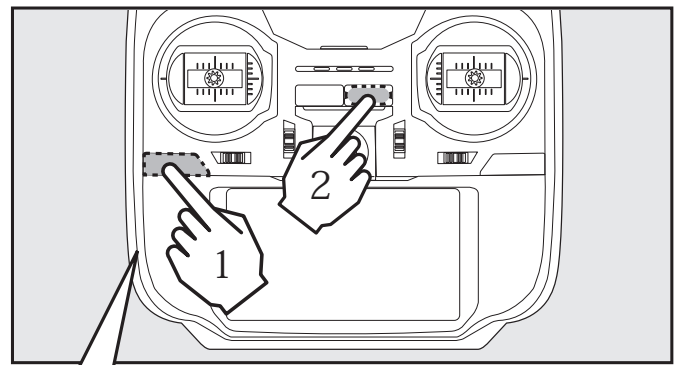

Press the HOME/EXIT switch and turn on

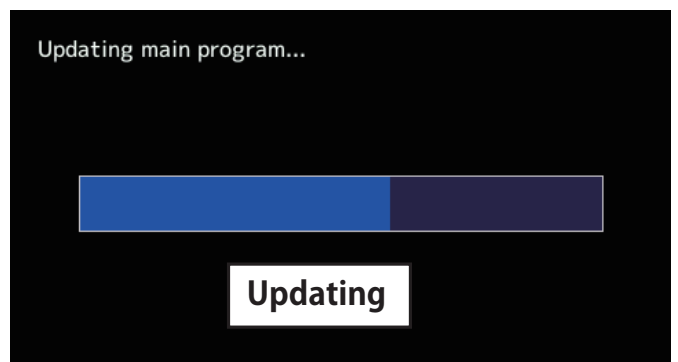

For FX-36

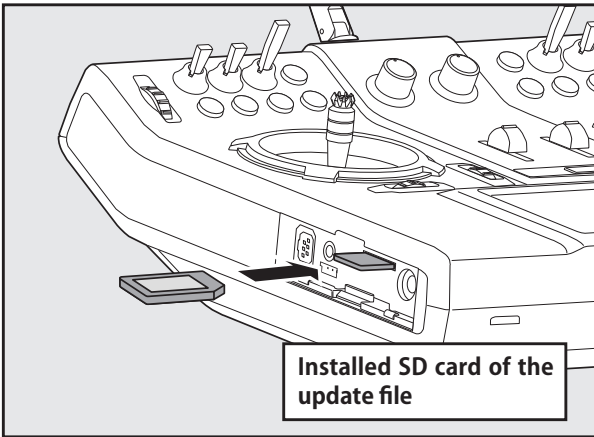

6. Turn on the transmitter power while pressing down the "H/E" button. The update screen appears on the LCD display of your transmitter and the software update is started.

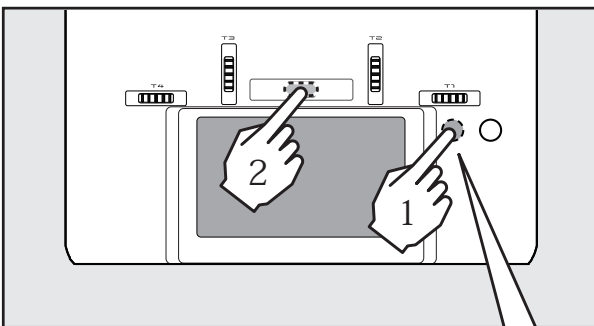

Press the H/E switch and turn on

7. When the software update is completed, "Completed" message is shown on the LCD display of your transmitter. (Show below picture.)

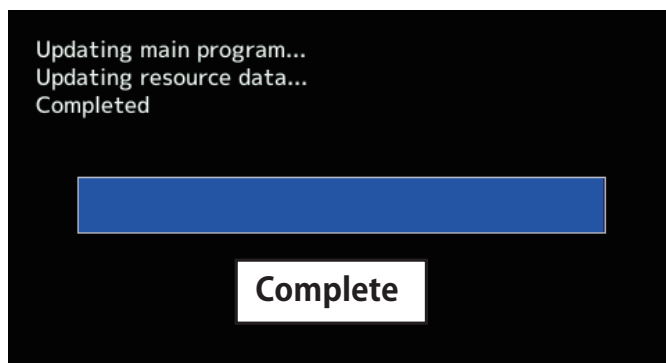

8. Turn off the power switch of your transmitter and remove the SD card from the card slot.

Possible Problems

When one of the error messages shown below appears on the LCD screen your transmitter, the software update will not be completed.

"Low battery."

Software update is postponed because of low battery. Retry the software update after the battery is recharged.

"Update file not found."

The transmitter cannot find the update file on the SD card. Check to be sure all the update files have been copied onto the SD card.

"Broken file."

The transmitter detects the update file error. The update file may be broken or for another transmitter.

"Write error."

The software update procedure is stopped for an unknown reason. Contact your local service center when this error message appears on the LCD screen of your transmitter.



Don't absolutely remove the battery and the SD card from the transmitter during the update.

There is a possibility that the transmitter will be damaged.

Recovering a failed update

If you failed to update for any reason, it may transmitter will not start.

In that case, please update again transmitter in the following procedure.

1. Detach the battery from the transmitter.
2. Insert the SD card that contained the update files to the transmitter.
3. Attach the battery to the transmitter while pressing down the "HOME/EXIT" button.
4. The update will start.

Even after the above steps, if the transmitter fails to update or does not start, please have it serviced.

T18SZ SOFTWARE UPDATE CHANGES

V4.1

This software updates or alters the functions and features noted below. The instructions and information that follow are meant as a supplement to the original instruction manual that accompanied the T18SZ transmitter. Please refer to the original instruction manual where applicable, but replace the steps indicated below with these instructions. Please check to ensure that the update has been installed.

- 1) Select the System Menu.
- 2) Touch the [Information] button.
- 3) Confirm that the information in the display indicates the version numbers as noted above.

1. Fixed telemetry voice for Futaba ESC and Hobbywing ESC.

V4

1. Compatible with Futaba ESC MC-980H/A, MC-9130H/A, MC-9200H/A

Supports the telemetry function of MC-980H/A, MC-9130H/A, and MC-9200H/A.

- ◆ Register the ESC with the transmitter. The registered ESC is displayed as "Futaba ESC".

- ◆ ESC telemetry display screen

The ESC status is displayed. Alarm setting is also possible.

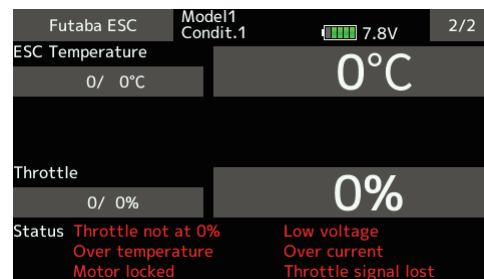
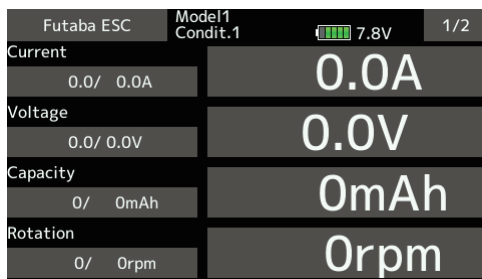

* The current and capacity consumption display may vary depending on the usage conditions, so use it as a guide.

2. Hobbywing ESC telemetry compatible

Supports the telemetry function installed in some Hobbywing ESCs.

- ◆ The registered ESC is displayed as "Hobbywing ESC".

For details on Hobbywing ESC telemetry support, refer to the Hobbywing website.

3. Compatible with SCORPION ESC telemetry

Added support for SCORPION POWER SYSTEM ESC some models.

This software updates or alters the functions and features noted below. The instructions and information that follow are meant as a supplement to the original instruction manual that accompanied the transmitter. Please refer to the original instruction manual where applicable, but replace the steps indicated below with these instructions. Please check to ensure that the update has been installed.

- 1) Select the System Menu.
- 2) Touch the [Information] button.
- 3) Confirm that the information in the display indicates the version numbers as noted above.

1. Fixed defect

Fixed a problem that could not be linked with R3206SBM.

V3.11

1. Fixed defect

Fixed a problem that telemetry reception time.

V3.10

1. Add O.S.ENGINE EM-100 Telemetry function

FASSTest, T-FHSS

Supports EM-100 firmware version Ver.8.00 or later.

V3.9



Important: When you update your radio to V3.9 and add the Model ID function, you must re-link existing FASSTest or T-FHSS receivers in your current models.

1. Add Model ID

FASSTest, T-FHSS

As an added level of safety in the form of Model ID, which will prevent the accidental control of a model when using a different model data by preventing link.

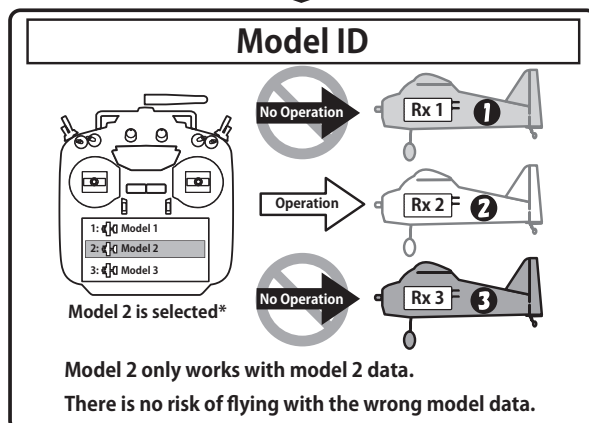
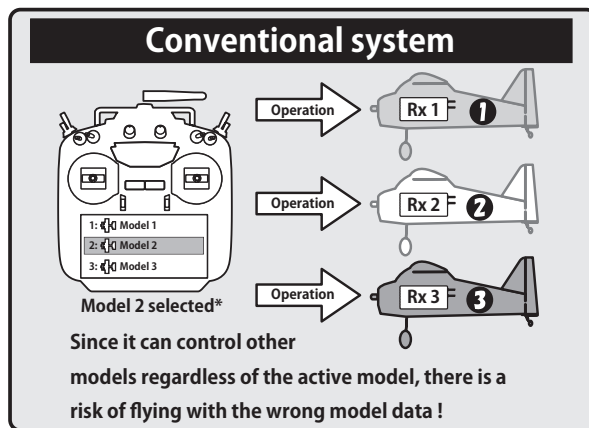



In Ver 3.9 or later software with the model ID function added, model data saved on the SD card cannot be called using the model select function. To use the model data of the SD card, copy the model data to the transmitter. If the model data of the SD card was selected before the update, an error message will be displayed at the first startup after the update, and the model will automatically switch to the model data of the transmitter.

Link is required when a new model is made from a model selection.

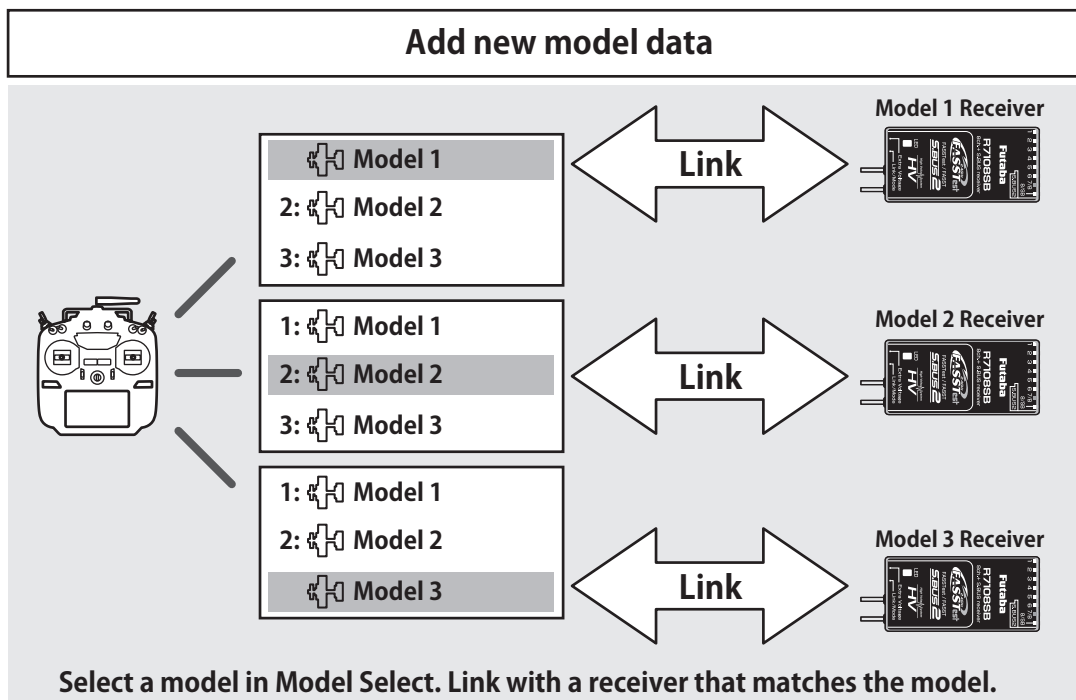

- In the system types (FASSTest, T-FHSS) compatible with the model ID function, a unique ID number (model ID) is set to each model data. Linking with a receiver stores the model ID of the model data in that receiver. The receiver operates only when it receives radio waves transmitted using model data that matches the stored model ID. As a result, the receiver does not operate even if model data of an unintended setting is used by mistake, so it is possible to prevent a malfunction due to a model selection mistake.

- If you want to use different model data from the model data that you have been using, link again.
- Model ID feature is enabled only if the system type is FASSTest or T-FHSS. Please note that model ID function can not be used on other systems.
- For safety reasons, model ID function can not be disabled.
- Model ID is automatically set when copying or adding model data.

When using R3004SB

- When using the **R3004SB**, set "Receiver" in the system type screen T-FHSS mode setting to [R3004SB]. When using other T-FHSS compatible receivers, set "Receiver" to [Normal].

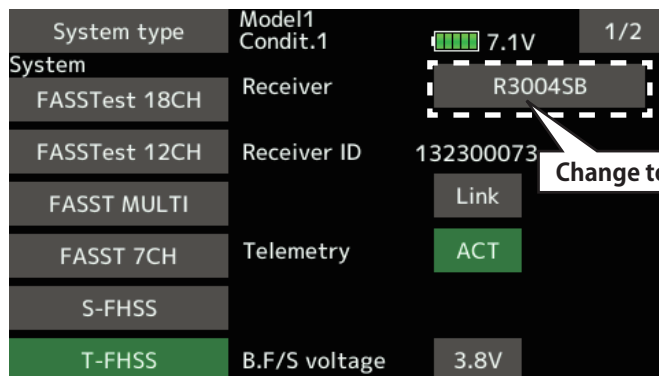

R3004SB receiver does not support model ID function.

2. Improved model copy function

Conventionally, only the model data currently active can be copied. In version 3.9, you can copy any model data.

This software updates or alters the functions and features noted below. The instructions and information that follow are meant as a supplement to the original instruction manual that accompanied the transmitter. Please refer to the original instruction manual where applicable, but replace the steps indicated below with these instructions. Please check to ensure that the update has been installed.

- 1) Select the System Menu.
- 2) Touch the [Information] button.
- 3) Confirm that the information in the display indicates the version numbers as noted above.

1. Telemetry sensor assignment

Third-party telemetry sensor JetCat V10 can be assigned from slot 1. This allows JetCat V10 and PowerBox to be used simultaneously.

- ### 1. Fixed defect
- Fixed a problem that an AFR rate of conditions 2 to 4 ("Gasvorw. 1" to "Gasvorw. 3") cannot be set properly when the language mode is set to German and model type of a model data is Helicopter.

1. Compatibility of model data created with T18SZ 70th anniversary model

It is necessary to update software to Ver.3.6 or later in order to use model data created with the T18SZ 70th anniversary model.

* There are no difference in functions between the 70th anniversary model and standard model.

1. Telemetry Airspeed sensor function

The T18SZ/T16SZ/FX-36 has been made compatible with the telemetry airspeed sensor.

◆ Airspeed sensor is registered with the transmitter.

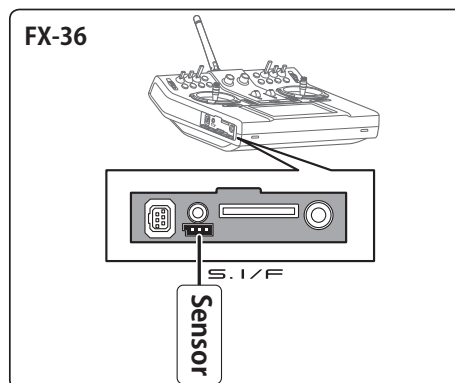
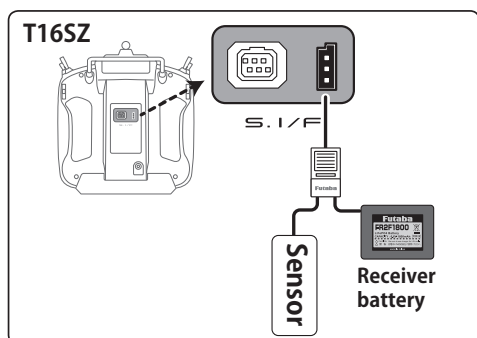
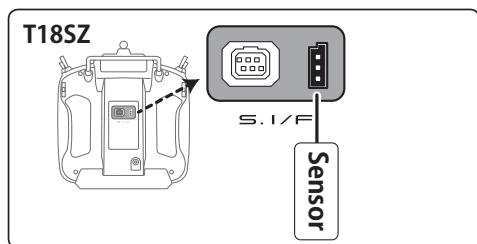

*Airspeed sensor must be installed in the aircraft.

- ① Connect the sensor to the transmitter as shown in the figure.
- ② [Linkage menu] → [Sensor] → [Page 3/3] is opened from the transmitter.
- ③ Tap [Register]
- ④ Complete registration and remove sensor from the transmitter.

◆ How to display the Airspeed sensor screen.

- ① [Linkage menu] → [Telemetry]

- ② Tap [Speed sensor]

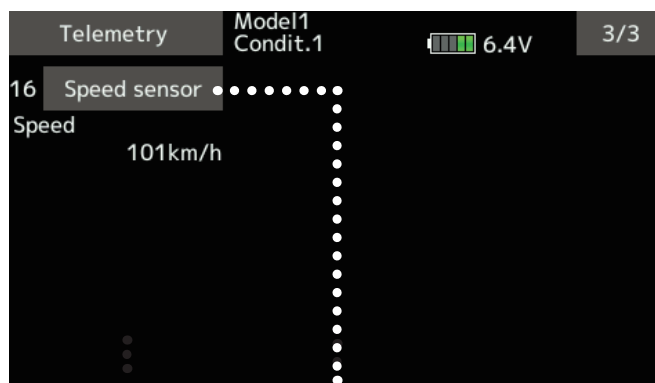

◆ Speed sensor screen

Max. and min. values since the power was turned ON will display.

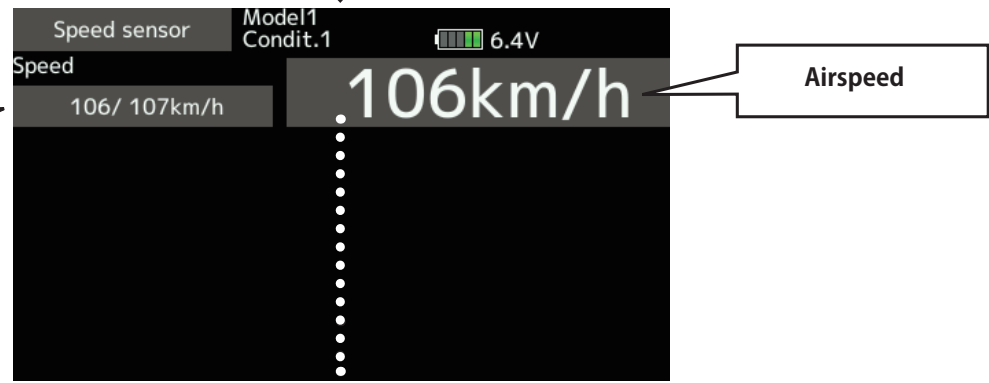

◆ Alarm setting

↑ An upward arrow indicates the alarm will sound when the speed reaches above your set value.

↓ A downward arrow indicates the alarm will sound when the speed reaches below your set value.

The ON/OFF switch of Speech is chosen.

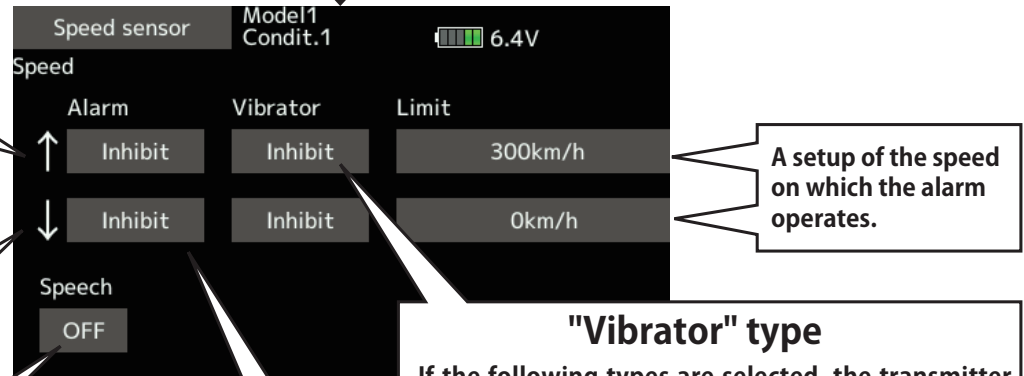

Alarm is chosen from Buzzer, Voice, and Inhibit.

"Vibrator" type

If the following types are selected, the transmitter will vibrate during the warning.

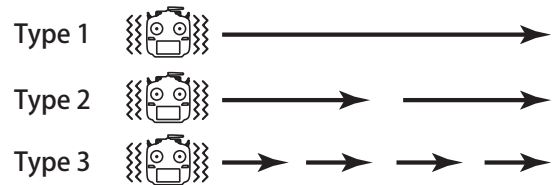

2. CRSF Protocol for TBS

The T18SZ/T16SZ/FX-36 has been made compatible with the CRSF (TBS) protocol.

■ Bidirectional communication function of CRSF is not supported.

① [Linkage menu] → [System Type] → [Page 2/2] is opened from the transmitter.

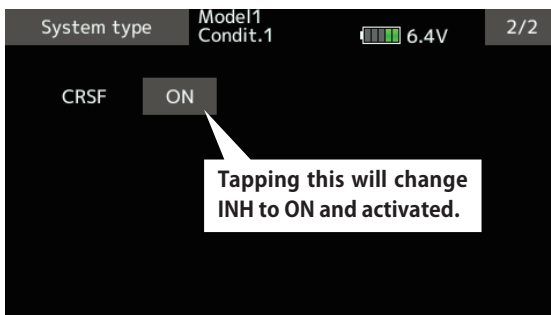

② Tap the "CRSF" button to [ON]. A signal conforming to the CRSF standard is output from the S.BUS setting connector (S.I/F) of the transmitter.

! Futaba is not responsible for damage sustained by combination with parts other than Futaba Genuine equipment.

■ When using CRSF, the S.BUS servo setting function and [Reload] [Register] [Change slot] functions cannot be used. When setting S.BUS servo and sensor, set CRSF to INH.

This software updates or alters the functions and features noted below. The instructions and information that follow are meant as a supplement to the original instruction manual that accompanied the T18SZ/T16SZ/FX-36 transmitter. Please refer to the original instruction manual where applicable, but replace the steps indicated below with these instructions. Please check to ensure that the update has been installed.

- 1) Select the System Menu.
- 2) Touch the [Information] button.
- 3) Confirm that the information in the display indicates the version numbers as noted above.

1. Fixed defect

- ◆ Fixed a problem that the power switch may not operate when the timer alarm is set to [Constant] mode.
- ◆ Fixed a problem that the position of the stick switch is not displayed correctly on the AFR. (FX-36 only)
- ◆ Fixed a problem that the power switch may not operate depending on the position of the trim dial. (FX-36 only)

This software updates or alters the functions and features noted below. The instructions and information that follow are meant as a supplement to the original instruction manual that accompanied the T18SZ/T16SZ/FX-36 transmitter. Please refer to the original instruction manual where applicable, but replace the steps indicated below with these instructions. Please check to ensure that the update has been installed.

- 1) Select the System Menu.
- 2) Touch the [Information] button.
- 3) Confirm that the information in the display indicates the version numbers as noted above.

1. Change of the trainer connector power supply specification

The update enables the trainer connector to supply power to external equipment connected to the trainer connector, when turning on the power by pressing the power switch in the trainer student mode.

2. Telemetry sensor made by O.S.ENGINES MFG.

It corresponds to O.S. EM-100 flight controller (under development). For details, please refer to the instruction manual of EM-100.

*The EM-100 is not handled at Futaba.

! Futaba is not responsible for damage sustained by combination with parts other than Futaba Genuine equipment.

! When connecting Futaba transmitters to the trainer cord, do not operate the power switch on the student side transmitter and operate the power switch on the teacher side transmitter as before. The student side transmitter turns power automatically in conjunction with the teacher side.

3. Fixed defect

- ◆ The count value of the integration timer has been corrected.
- ◆ Fixed the behavior of Ailevator.
- ◆ Fixed a problem that the power switch infrequently does not work.

This software updates or alters the functions and features noted below. The instructions and information that follow are meant as a supplement to the original instruction manual that accompanied the T18SZ transmitter. Please refer to the original instruction manual where applicable, but replace the steps indicated below with these instructions. Please check to ensure that the update has been installed.

- 1) Select the System Menu.
- 2) Touch the [Information] button.
- 3) Confirm that the information in the display indicates the version numbers as noted above.

1. Telemetry display (The extension of the number of telemetry data which is shown)

The number of telemetry data shown on the Telemetry display screen is extended. It is 16 items (4 pages) maximum.

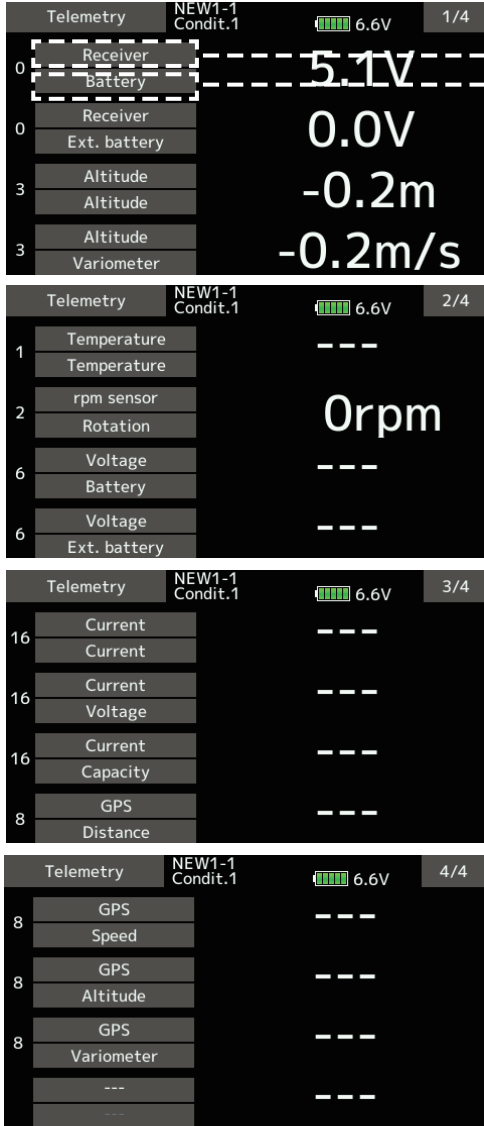

Sensor type selection screen

You can choose which type of sensor to display. Tap the sensor type.

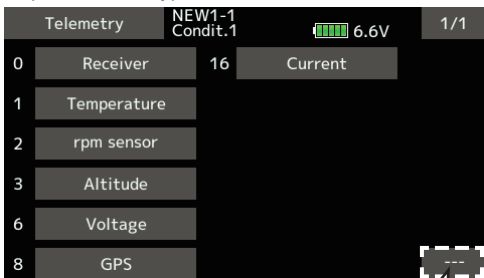

If you do not want to display telemetry data on the telemetry monitor screen, select "----".

Sensor selection screen

For some sensor types, you can choose the display item. Tap to select.

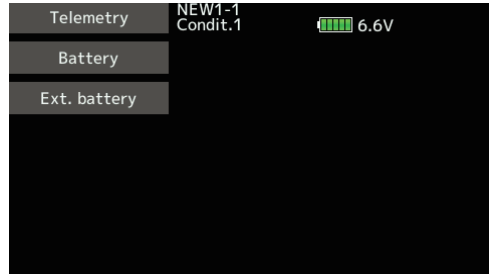

2. Timer Alarm

Added a setting to continue the alarm after the alarm set time.

Constant: The alarm does not stop
One time: Stop the alarm at once



3. Model select

Model data of FX-32 can be used.

4. Data Converter

FX-30 and T12FG have been added to the data converter compatible models.

The transmitter name is displayed on icon.

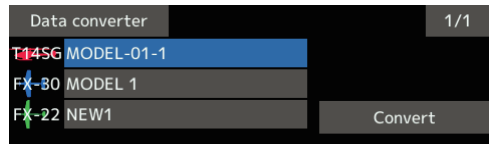

5. Butterfly Elevator setting (Glider)

Added fine tuning function to butterfly elevator setting.



*If the type selected is flying wing, the Elevator setting will not appear.

6. Butterfly mixing mode (Glider)

The operation of Butterfly mixing was changed.

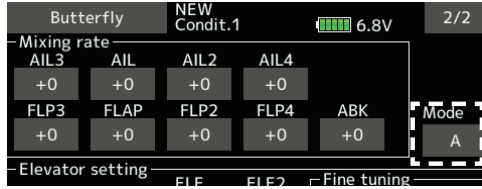

Mode A, mode B selection added.

- **Mode A**

(Normal)

- The butterfly operation direction is reversed at the neutral position (50%) of the throttle stick.

At offset 20



At offset 70

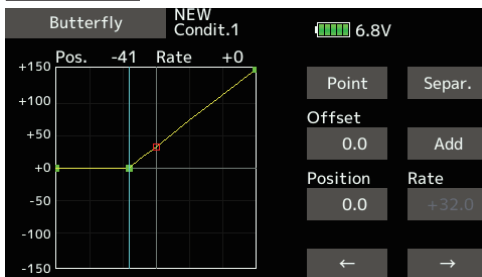

The direction of butterfly motion is reversed.

- **Mode B**

(Throttle stick full stroke MODE)

- It does not reverse at the neutral position, so you can set the butterfly operation start point with the full stroke of the throttle stick.

At offset 20



At offset 70



The direction of butterfly motion is not reversed.

7. Butterfly Differential rate (Glider)

The operation of Butterfly Differential rate was changed.

- ◆ When Butterfly Differential rate is "+", Up rate is decreased and DOWN rate is increased.
- ◆ When Butterfly Differential rate is "-", the calculation method of UP/DOWN and a direction become reversed.

8. Error correction for Failsafe screen

A fault that a fail-safe position indicator is not shown on the Failsafe screen in FASST-7ch mode has been fixed.

This software updates or alters the functions and features noted below. The instructions and information that follow are meant as a supplement to the original instruction manual that accompanied the T18SZ transmitter. Please refer to the original instruction manual where applicable, but replace the steps indicated below with these instructions. Please check to ensure that the update has been installed.

- 1) Select the System Menu.
- 2) Touch the [Information] button.
- 3) Confirm that the information in the display indicates the version numbers as noted above.

1. Information (System menu)

Two pages of manual QR code and manufacturer information are added to the information.

Information

Page 2 : Manual QR code

Page 3 : Manufacturer Information

Tap to page 2
Tap to page 3
Tap to page 1

You can download the instruction manual (English · Japanese) by scanning the QR code with a compatible tablet or smart phone.

Tap to display Open source license

2. Add INT (Integration) Timer (Linkage menu)

INT (integration) Timer is the function which changes progress of a timer according to the location of the throttle stick. When the throttle stick is raised for faster speed, the speed of the timer usually increases. With the throttle stick at mid-range speed, the timer speed decreases (to 50%). When the throttle is positioned at low end, the timer's progress stops. It's possible to set it in the time which fits the power consumption of your aircraft.

*The consumption of the battery/fuel is different depending on the conditions, so use an INT Timer as reference.

*The INT (integration) time is different from the actual elapsed time.

				When a throttle stick is the high side, the speed of the timer usually increases.
<hr style="border-top: 1px dashed black;"/>				
				When a throttle stick is middle-speed, the timer speed decreases (by 50%).
<hr style="border-top: 1px dashed black;"/>				
				When a throttle stick is low, timer progress stops.

- Select [Timer] at the linkage menu and call the setup screen shown below.

Percentage to set time

INT Time

Start INT timer

Normal Timer

Tap ---

TH% : Integration Timer

--- Normal Timer
TH% INT (Integration) Timer

3. Add T14SG/FX-22 → T18SZ MODEL DATA CONVERSION

The model data (only latest version) of T14SG/FX-22 can be copied to T18SZ.

- * SD card is required.
- * The model data of T18SZ cannot be copied to T14SG/FX-22.
- * Functions in T14SG/FX-22, functions not in T18SZ are not converted.

[Model data conversion method]

1. Attach an SD card that contains model data of T14SG or FX-22 to the SD slot of a T18SZ.
2. Turn on the power switch, and the Data Converter should run.

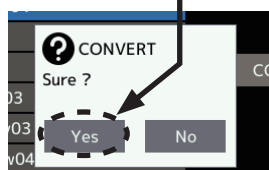

3. The converter shows a list of model data in the card. Select a model data that you want to convert and push "CONVERT" → "Yes" key, and the converter should begin converting data.
4. If the conversion succeeds, the converter will show the following message. The converted data are copied to the internal memory of the T18SZ. Hence, if the T18SZ does not have available space in its internal memory, conversions must fail.

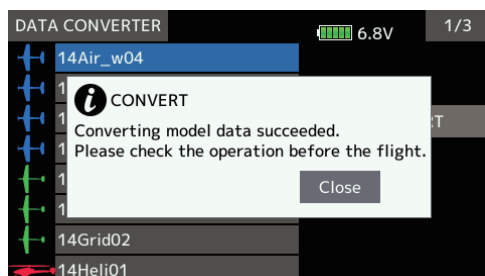

5. The converter can accept model data made by T14SG or FX-22 with the latest software only. If you try to convert model data made by old version

software, the converter must fail to convert and show the following error message. If this message is shown, do the following procedure to update the model data in order to avoid this limitation.

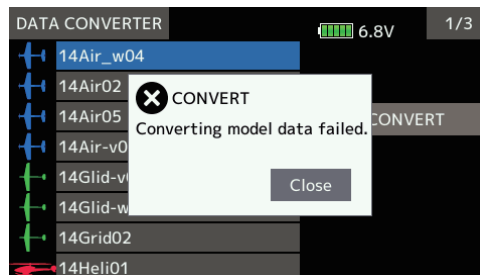

- (a) First, update a T14SG or FX-22 to the latest software.
- (b) Load the model data which failed to convert into the T14SG or FX-22 with the latest software, and the model data should be updated to the latest format.
- (c) Save the updated model data to an SD card.
- (d) Retry to convert the updated model data on a T18SZ.

*When an SD card cannot be recognized, it may still be usable if reformatted. Download the SD formatter from the SD Association.
<https://www.sdcard.org/> (As of June, 2017)

⚠ CAUTION

- ⚠ After finishing data copy, be sure to perform a complete check of operation with the model to be used.
- ⚠ Check well all the directions of operation and all the operation switches.

Important: Always check the operation of the model prior to flight.

4. Trim screen display name change (linkage menu)

It changed with **T1 - T6 setting** → **Trim setting**. Also the display name of **T1 - T6** of data reset was changed to **Trim**.

*There is no change in function or setting method.

5. Add Language Traditional Chinese, Simplified Chinese (System menu-Information)

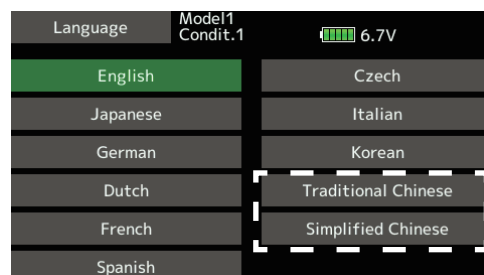

This software updates or alters the functions and features noted below. The instructions and information that follow are meant as a supplement to the original instruction manual that accompanied the T18SZ transmitter. Please refer to the original instruction manual where applicable, but replace the steps indicated below with these instructions. Please check to ensure that the update has been installed.

- 1) Select the System Menu.
- 2) Touch the [Information] button.
- 3) Confirm that the information in the display indicates the version numbers as noted above.

1.The following faults about telemetry function have been fixed.

1. GPS data that a PowerBox measured are not displayed.
2. Several data that a JetCat V10 measured are not displayed.
3. The transmitter freezes at the screen to choose data type of JetCat V10 to show on the telemetry monitor screen from the Home screen when you tap the title button in the screen to choose data type.

This software updates or alters the functions and features noted below. The instructions and information that follow are meant as a supplement to the original instruction manual that accompanied the T18SZ transmitter. Please refer to the original instruction manual where applicable, but replace the steps indicated below with these instructions. Please check to ensure that the update has been installed.

- 1) Select the System Menu.
- 2) Touch the [Information] button.
- 3) Confirm that the information in the display indicates the version numbers as noted above.

1. Vario Melody Setting

Vario Melody Setting is added to the variometer of the Altitude Sensor and GPS sensor.



Tap the [Set] button

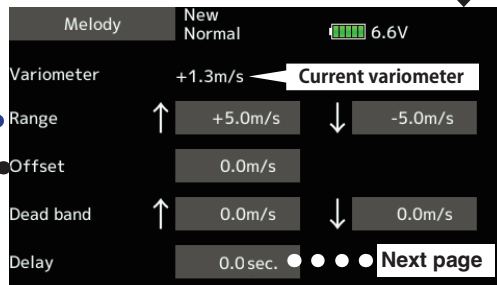

*These settings can be made for each sensor.

Range

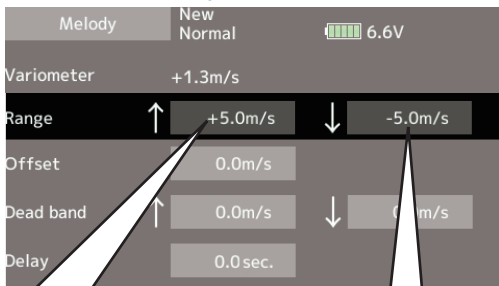

When the variometer is greater than this value, Vario melody is not variable.
Setting range :
 Offset value ~ +50m/s
Initial value : 5.0m/s

When the variometer is less than this value, Vario melody is not variable.
Setting range :
 -50m/s ~ Offset value
Initial value : -5.0m/s

Deadband



When the variometer is less than this value, Vario melody is not output.
Setting range : 0m/s ~ +50m/s
Initial value : 0.0m/s

When the variometer is greater than this value, Vario melody is not output.
Setting range : -50m/s ~ 0m/s
Initial value : 0.0m/s

Offset

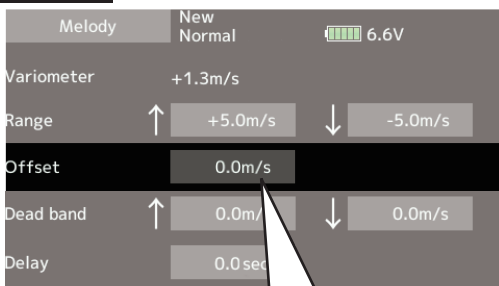

This is the changing point of climb and sink. When the variometer is greater than this value, Vario Melody is climb type. When the variometer is less than this value, Vario Melody is sink type.
Setting range : Range ↑ setting value ~ Range ↓ setting value
Initial value : 0.0m/s

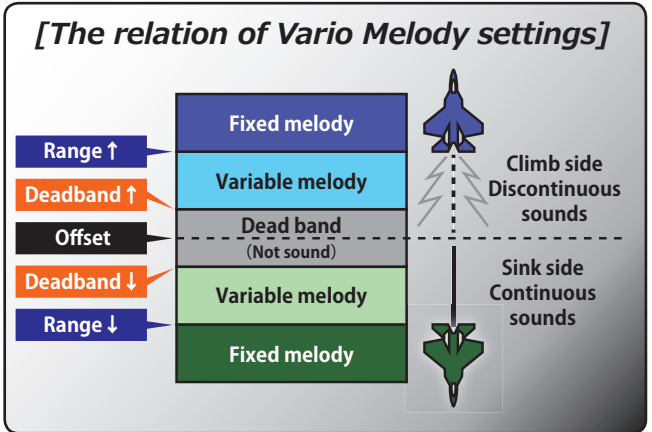

Delay

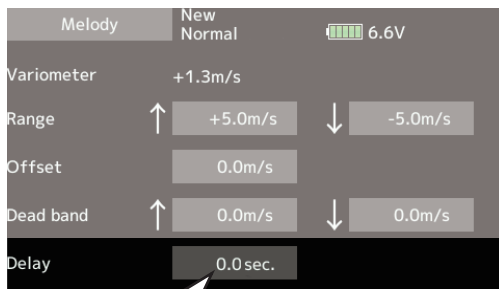

The output vario melody does not change during the delay time. In other words, this is a minimum time of Vario melody output.

Setting range : 0.0 s, 0.5 s, 1.0 s, 1.5 s

Initial value : 0.0 s

*This parameter is effective to all variometers.

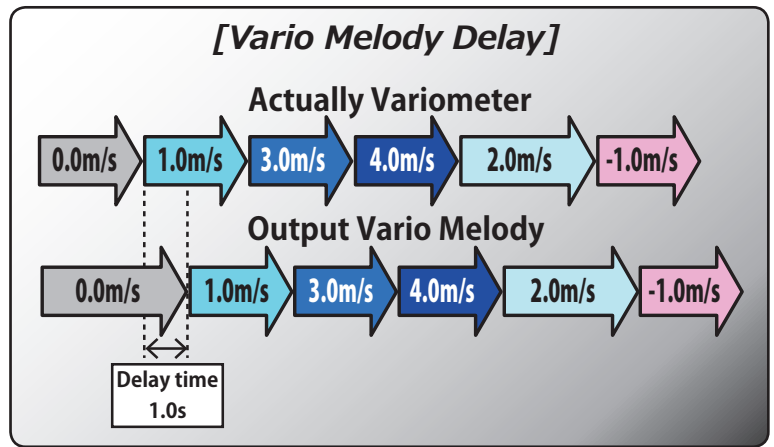

2. Telemetry Alarm Duration and Repeat time

The repeat time and duration time for the telemetry alarm (buzzer, vibration and speech) can be set.

Tap the [Telemetry Setting] button in the Linkage menu to call the setup screen shown below.

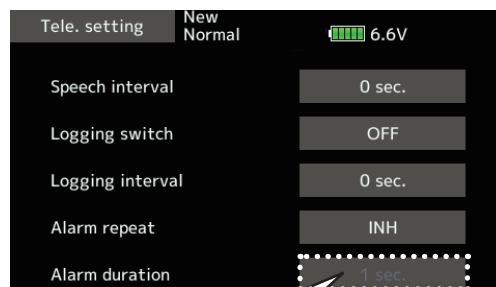

Duration is not displayed when Repeat is INH.

Duration

It is an alarm output time.

Setting range : 1 s ~ 30 s

Initial value : INH

Duration value has to be less than repeat value.

Duration time is extended when the other alarm event occurs.

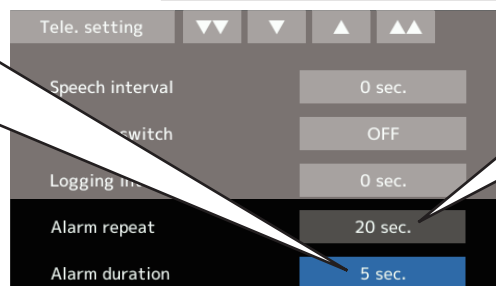

Repeat

It is a repeat time of an alarm output.

Setting range : INH, 1 s ~ 240 s

Initial value : INH

[Duration and Repeat time for Telemetry Alarm]

e.g. Repeat time is 8 seconds and Duration time is 5 seconds.

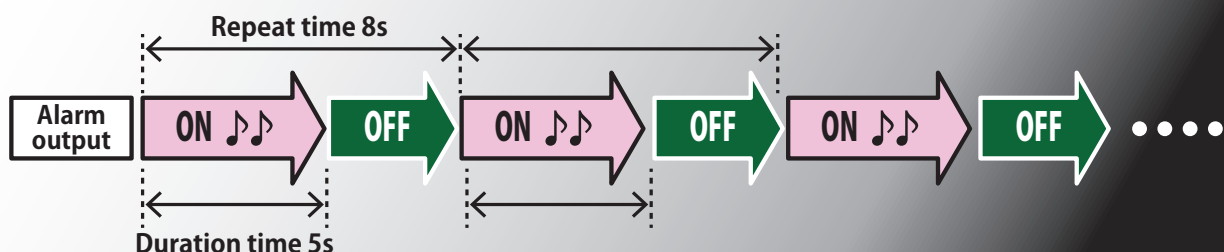

3. French speech localization

French localization of telemetry speech function is available. If you would like to use the French speech function, update software of your T18SZ to the French version of the new software.

4. Stick mode

Mode 3 and 4 have been added.

This software updates or alters the functions and features noted below. The instructions and information that follow are meant as a supplement to the original instruction manual that accompanied the T18SZ transmitter. Please refer to the original instruction manual where applicable, but replace the steps indicated below with these instructions. Please check to ensure that the update has been installed.

- 1) Select the System Menu.
- 2) Touch the [Information] button.
- 3) Confirm that the information in the display indicates the version numbers as noted above.

1. Fault corrections : V1.9 (trainer)

A defect causing the trainer function to not work properly in S-FHSS mode has been fixed.

2. Fault corrections : V1.8 (setup screen with curve setting)

If you make a mixing setting that moves a master function to enormous travel, for example Programmable mixing whose master and slave are assigned to any same function, T18SZ restarts as you open a setup screen of a mixing that uses the master function.

3. Change of a sensor name : V1.8

"Kosmik ESC" has been changed to "Kontronik ESC".

4. Korean language : V1.7

Korean language is available. Choose "Korean" from Language select buttons in the Information screen.

5. Fault corrections : V1.6 (GPS Indication)

A problem of data from GPS units not being shown was determined on v1.5 software. V1.6 has corrected the issue.

6. Hysteresis-type and box-type can be selected in a hardware select screen.

When a stick, trim lever, or VR is used as a switch, the following 4 modes can be selected.

◆ Linear • Hysteresis mode

This setting method selects function ON/OFF based on the set point. Hysteresis (dead band) can be set to ON and OFF. The ON and OFF positions can be reversed with the Reverse button.

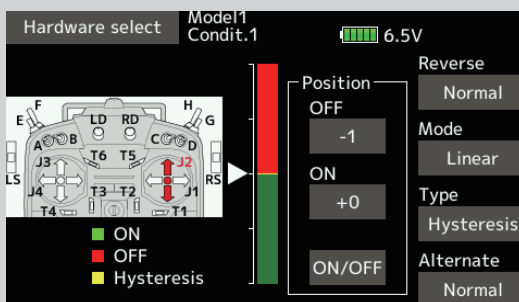

◆ Symmetry • Hysteresis mode

The operation is the same as the linear hysteresis mode, but left and right (up and down) operations are symmetrical about the neutral position. For example, when you want to switch DR1 with the aileron stick, when the stick is moved to the left or right, DR1 can be turned ON at the same left and right position.

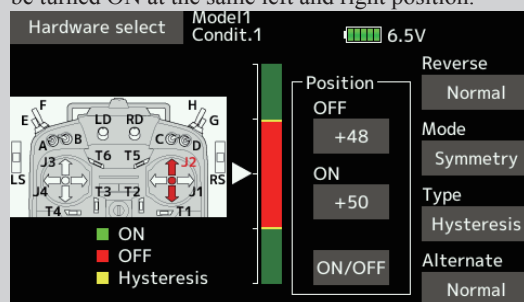

◆ Linear • Box mode

This mode turns on the switch within a range of 2 points. Each point can be set. The ON and OFF positions can be reversed with the Reverse button.

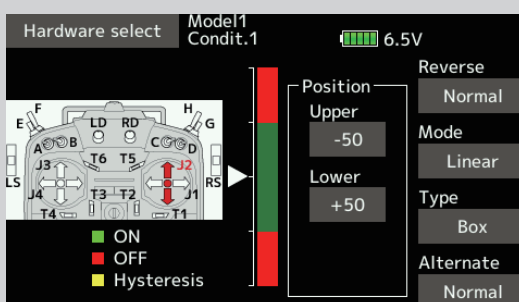

◆ Symmetry • Box mode

The operation is the same as the linear box mode, but left and right (up and down) operation is symmetrical about the neutral position.

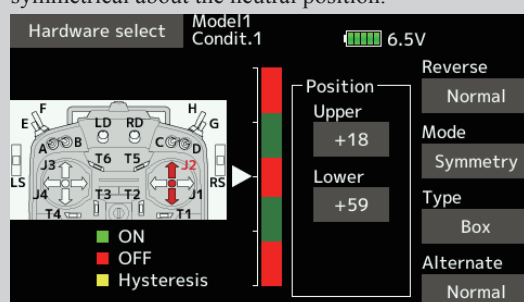

When shifting the ON/OFF point

The ON/OFF and hysteresis (dead band) boundary point (there are 2 points: top and bottom) position can be shifted. ON/OFF is possible at a free position.

- ◆ Area Green : ON
- ◆ Area Red : OFF
- ◆ Area Yellow : Hysteresis (Dead band)

[Setting method]

1. Move the stick, etc. to the point you want to shift and touch the [ON/OFF] button. The boundary points change.

Current stick position

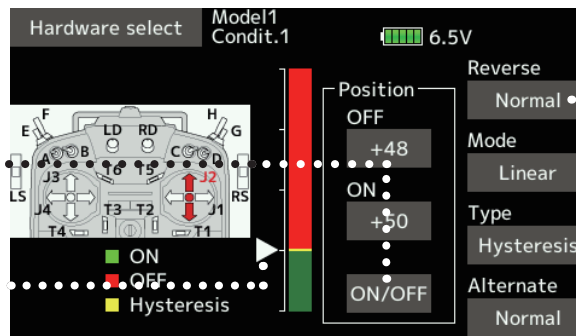

Reverse of ON/OFF direction

[Setting method] → Box Type

1. Move the stick to the point you want to shift upper side.
2. Touch the [Upper] button. The boundary points change.
3. Move the stick to the point you want to shift lower side.
4. Touch the [Lower] button. The boundary points change.

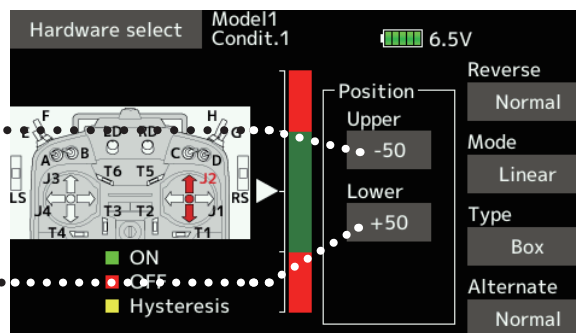

● Symmetry

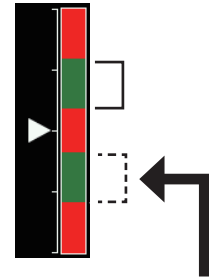

When Upper (Lower) is set, at the same time, Lower (Upper) is also set.

Hysteresis : Hysteresis (dead band) can be set to ON and OFF

[Setting method] → Linear Type

1. Move the stick to the off point you want to shift and touch the [OFF] button. The off points change.
2. Move the stick to the on point you want to shift and touch the [ON] button. The on points change.

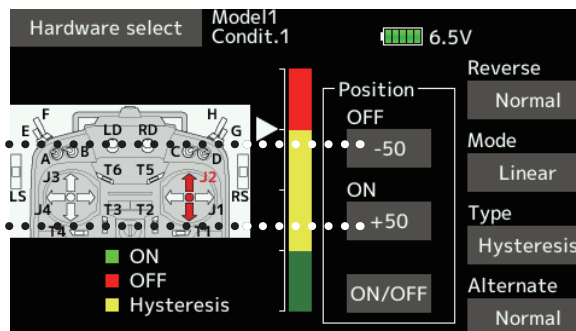

● Symmetry

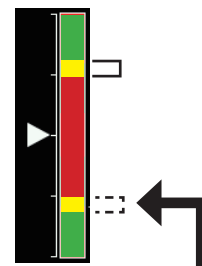

When Upper (Lower) is set, at the same time, Lower (Upper) is also set.

7. It corresponded to the following sensors.

Refer to the sensor instruction manual for more information.

- Kontronik ESC
- Castle TLO
- JetCat V10
- PowerBox

This software updates or alters the functions and features noted below. The instructions and information that follow are meant as a supplement to the original instruction manual that accompanied the T18SZ transmitter. Please refer to the original instruction manual where applicable, but replace the steps indicated below with these instructions. Please check to ensure that the update has been installed.

- 1) Select the System Menu.
- 2) Touch the [Information] button.
- 3) Confirm that the information in the display indicates the version numbers as noted above.

1. Curve setting operation

Point curves or spline curves of up to 11/17 points can be used. (Initial value: 11/9 points) **The set points can be freely increased, decreased, and offset.**

◆ Point addition method

- ① Open the screen of a mixing curve with the curve function.

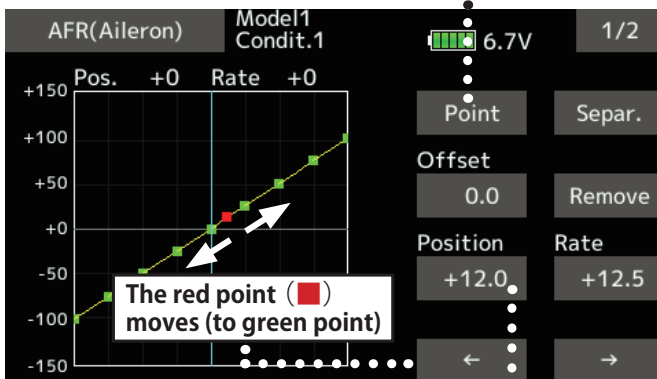
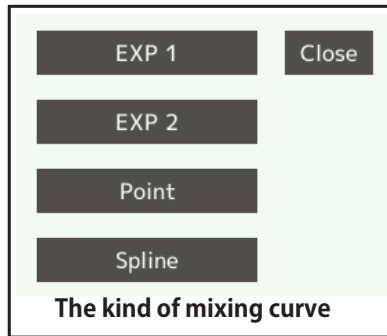

- ② Tap the "Position" button.

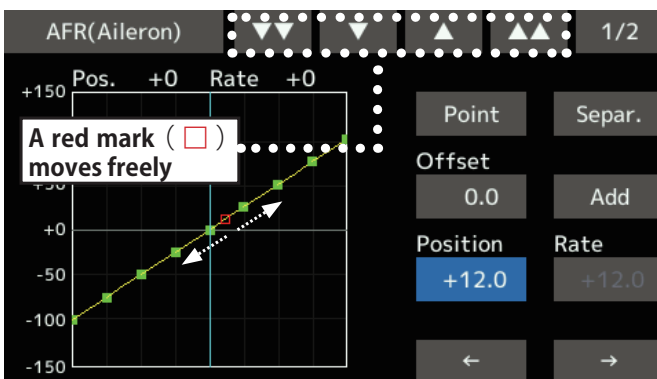

- ③ Tap the "▼▼" "▼" "▲" "▲▲" button and select the position (mark red square) you want to add.

- ④ When the "Add" is tapped, the point is added. (red square) → (red square)

*A new point is created.

- ⑤ Press "Rate" and use the up/down arrows to adjust the rate points up or down.

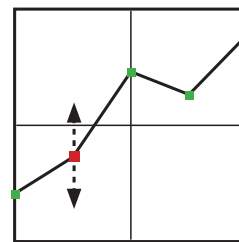

◆ Point deletion method

- ① Use the move between points button [←] or [→]

and select the point. (The red point is the selected point.)

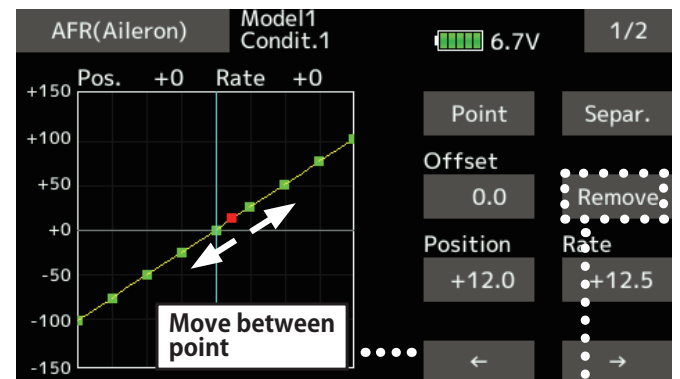

- ② Tap the [Remove] button. (The selected point becomes an outlined point red square)

- ③ Use the move between points button [←] or [→].

*The point is deleted.

2. Curve setting operation Spline curve

Addition of spline curve setting.

Setting method is same at spline and point.

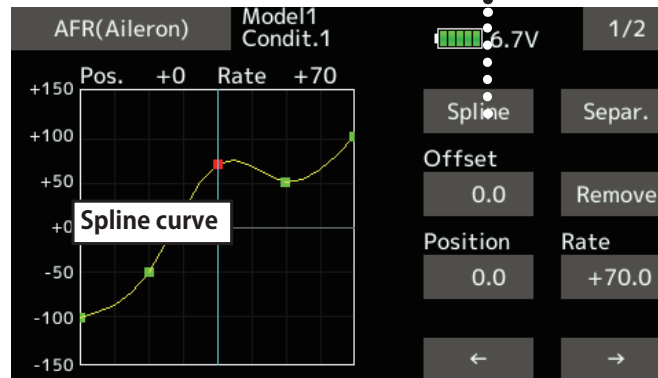
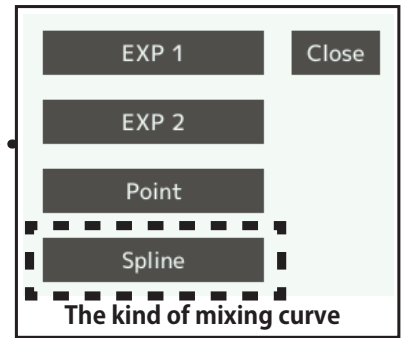
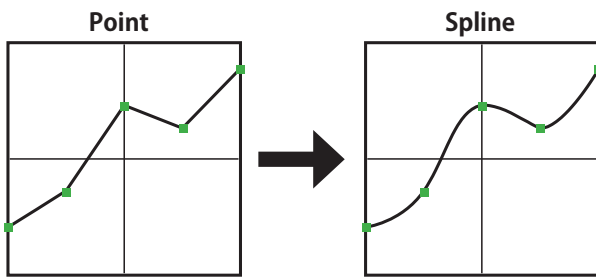

3. SBS-01C current sensor function

The T18SZ has been made compatible with the SBS-01C current sensor. The SBS-01C has the capability of measuring current, voltage and capacity (consumption) from the drive battery at the same time.

*Current sensor must be installed in the aircraft.

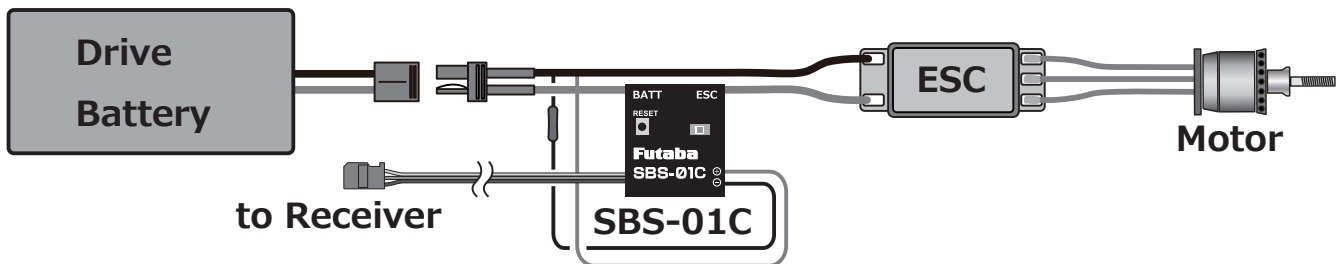

◆ SBS-01C is registered with a transmitter.

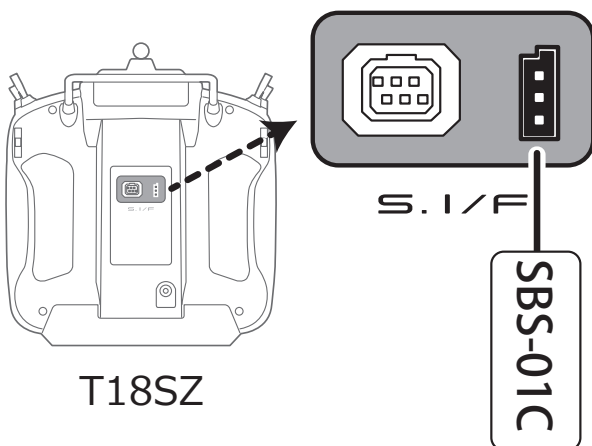

- ① Connect the sensor to the T18SZ as shown in the figure above.
- ② [Linkage menu] → [Sensor] → [Page 3/3] is opened from the T18SZ.
- ③ Tap [Register]
- ④ Complete registration and remove SBS-01C from the transmitter.

◆ **Calling of a current sensor screen.**

① [Linkage menu] → [Telemetry]



② Tap [Current]

◆ **Current sensor screen**

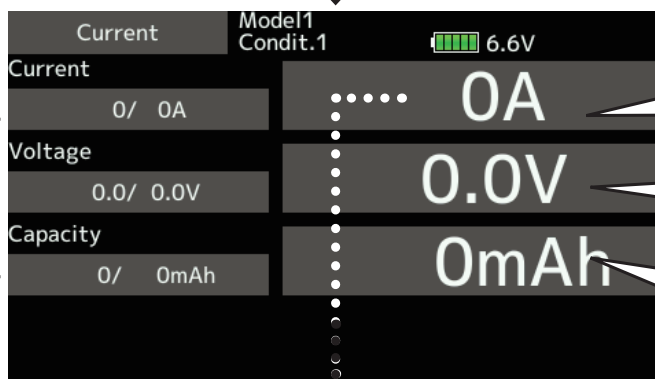

Max. and min. values since the power was turned ON will display.

Tapping this will take you to the settings screen for the current alarm

Tapping this will take you to the settings screen for the voltage alarm

Tapping this will take you to the settings screen for the consumption capacity alarm

◆ **Alarm setting**

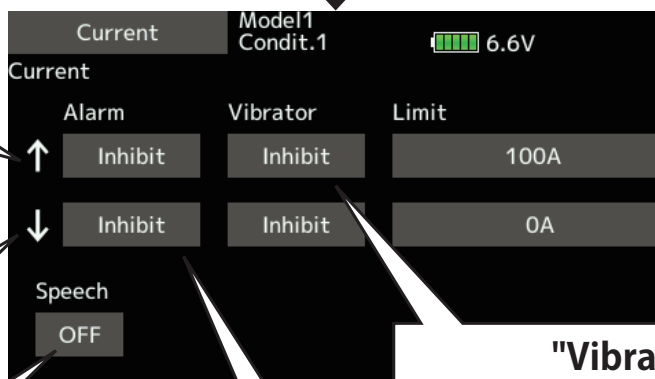

↑ An upward arrow indicates the alarm will sound when the current reaches above your set value.

↓ A downward arrow indicates the alarm will sound when the current reaches below your set value.

The ON/OFF switch of Speech is chosen.

Alarm is chosen from Buzzer, Voice, and Inhibit.

A setup of the current on which the alarm operates.

"Vibrator" type
 If the following types are selected, the transmitter will vibrate during the warning.

Type 1 →

Type 2 → →

Type 3 → → →

4. SD card icon

● When model data on a SD card is used, this icon appears.

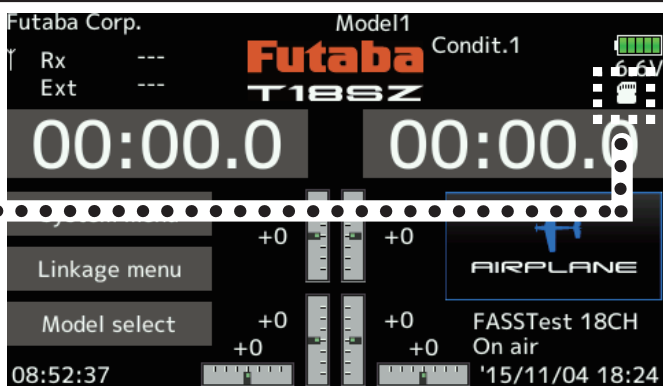
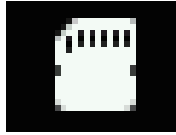

5. Stick mode

Addition of stick mode function.

Mode 2 or Mode 1 can be chosen.

But, it isn't changed until data is reset.

To change the mode the stick ratchet must be changed. Request that this be done by Futaba Service. (Charged modification)

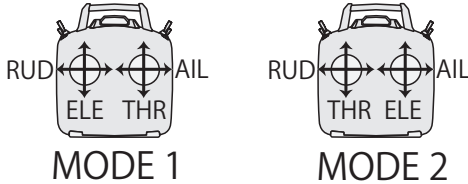

◆ System menu change

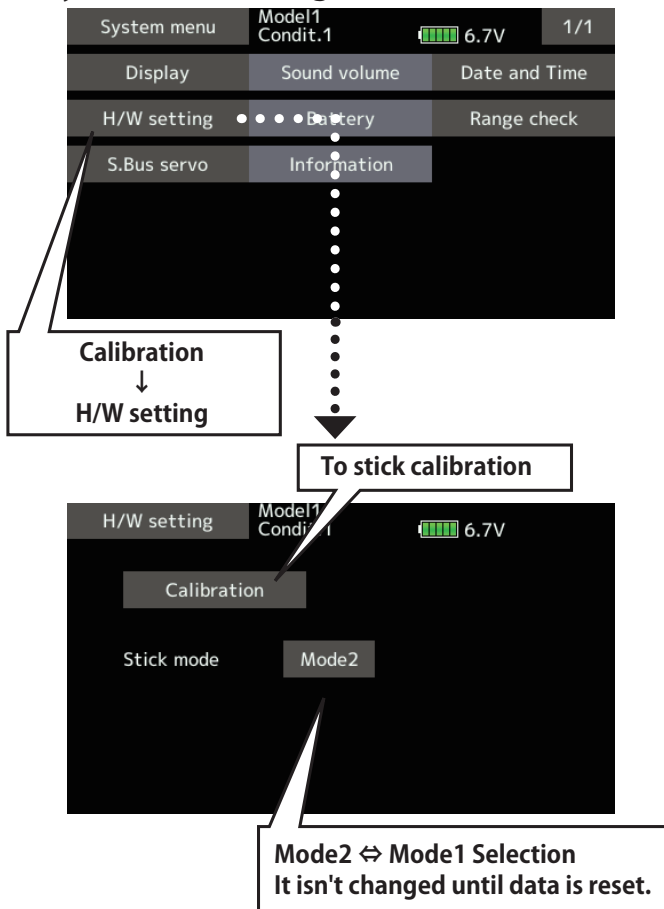

6. Throttle stick position alarm

< Airplane/Glider >

When the old version makes the function of the throttle stick a motor, a throttle stick position alarm has not started.

When the new version makes the function of the throttle stick a motor, a throttle stick position alarm has started.

7. Name change on the model menu

< Airplane/Glider >

Model menu	Model1 Condit.1	6.4V	1/2
Servo monitor	Condition select	AFR	
Dual rate	Program. mixes	Aileron differential	
Flap setting	AIL → Camber flap	AIL → Brake flap	
Aileron → Rudder	Elevator → Camber	Camber mixing	
Airbrake → ELE	Camber flap → ELE	Rudder → Aileron	
Rudder → Elevator	Snap roll	Air brake	

8. Butterfly elevator curve function

< Glider >

- When offsetting the butterfly operation reference point, operate to the point you want to change and then touch the Offset button. The reference point displays 0%. When [Yes] is touched, the reference point is changed. Then, "Initialize elevator curve?" appears, allowing you to confirm your setting.

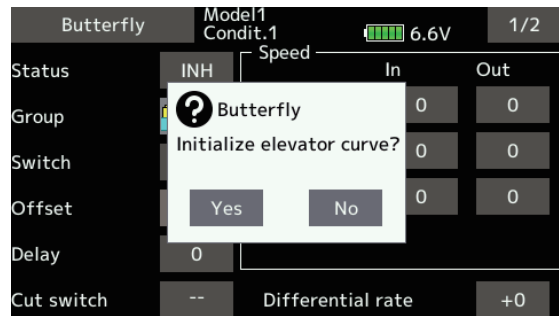

- The offset position is indicated by a red dotted line by an elevator curve.

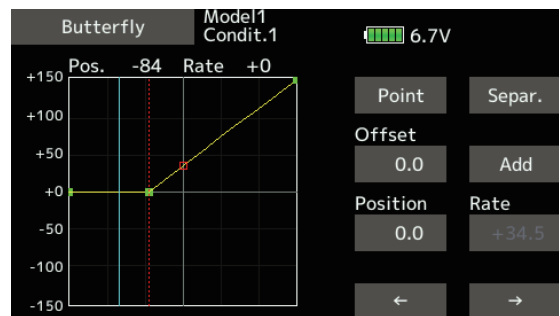

9. T-FHSS dual receiver function

< T-FHSS >

The dual receiver function can't be used for T-FHSS. When T-FHSS is chosen, dual receiver function isn't shown on a system type screen.